

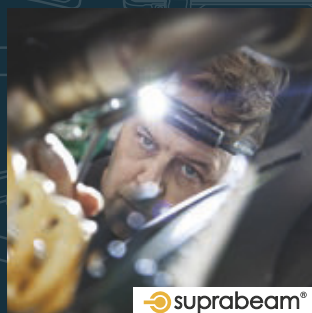

Distribution

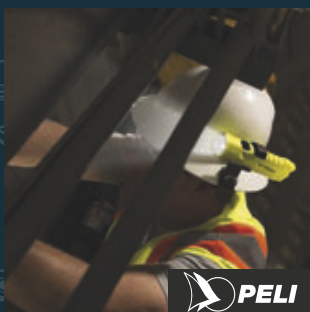

2026/2027



Seit der Gründung im Jahr 1952 steht die Heinz Hesse KG für Kompetenz im Werkzeug- und Industriebedarf. Was als Handelsvertretung für Kleineisenwaren, Beschläge und Schraubwerkzeuge begann, hat sich über Jahrzehnte zu einem leistungsstarken Vertriebspartner für den Werkzeugfachhandel entwickelt.

Unser Sortiment ist kontinuierlich mit den Anforderungen unserer Kunden gewachsen. Heute bieten wir ein breites, sorgfältig abgestimmtes Produktsortiment für Industrie und Handwerk – bestehend aus Qualitätsmarken und komplementären Lösungen, die im täglichen Einsatz überzeugen.

Als vertrauenswürdiger Distributionspartner namhafter Hersteller der Werkzeugbranche verstehen wir uns als Bindeglied zwischen Industrie und Fachhandel. Langjährige Partnerschaften, klare Vertriebsstrukturen und Marktkenntnis bilden dabei die Grundlage unseres Handelns.

In den vergangenen Jahren haben wir gezielt in Digitalisierung und moderne EDV-Strukturen investiert. Effiziente Prozesse, aktuelle Warenwirtschaftssysteme und strukturierte Daten ermöglichen eine zuverlässige und transparente Zusammenarbeit mit unseren Kunden.

Auch im Bereich Lager und Logistik setzen wir auf Innovation: Ein gut ausgestattetes Lager sowie moderne Lösungen wie ein vertikales Umlaufregal sorgen für schnelle Verfügbarkeit, strukturierte Abläufe und eine hohe Liefertreue.

Als Familienunternehmen stehen wir seit über 70 Jahren für Verlässlichkeit, Qualitätsbewusstsein und partnerschaftliche Zusammenarbeit. Die Fortführung in der dritten Generation sichert Kontinuität, langfristiges Denken und unternehmerische Stabilität.

Heinz Hesse KG
Thomas Hesse



Gesamtprogramm 2026/2027

Für mehr Infos auf:
www.heinz-hesse-kg.de



Weidmüller 

Seite 07 - 22

JOKARI
original

Seite 23 - 28

SapiSelco

Seite 29 - 38

HellermannTyton

Seite 39 - 42

Roll-Profi

Seite 43 - 44

★★★★
SB

Seite 45 - 48

EB[®]

Seite 49 - 50

 **MENNEKES**
MY POWER CONNECTION

Seite 51 - 56

gt
Line

Seite 57 - 62

PLANO

Seite 63 - 66

Tayg

Seite 67 - 68

NLG

Seite 69 - 70

 **PELI**

Seite 71 - 87

 **suprabeam**[®]

Seite 88 - 92

Leica
Geosystems

Seite 93 - 96

Hultafors

Seite 97 - 112

Tajima

Seite 113 - 118

LUTZ **BLADES**[®]
exactly

Seite 119 - 126

NT Cutter

Seite 127 - 130

 **LEATHERMAN**[®]

Seite 133 - 135

Koken

Seite 146 - 163

EIGHT[®]

Seite 164

IREGA
THE ADJUSTABLE IS OUR WORLD

Seite 165 - 166

 **ROUGHNECK-
GORILLA**

Seite 176 - 178

Kabelverarbeitung

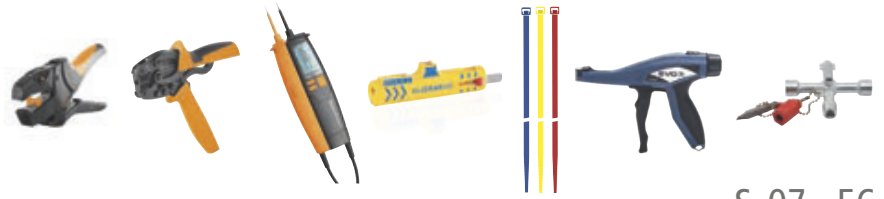

S. 07 - 56

1

Koffer | Taschen



S. 57 - 80

2

Licht



S. 83 - 92

3

Messen



S. 93 - 112

4

Schneiden



S. 113 - 144

5

Werkstattbedarf

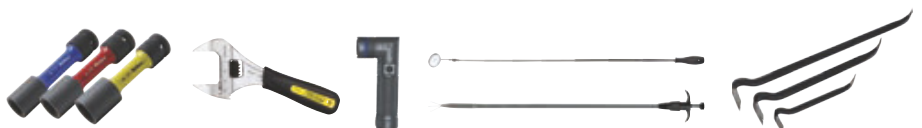

S. 145 - 178

6

Kabelverarbeitung

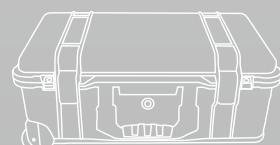
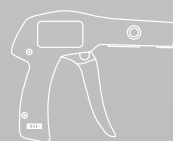
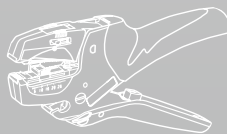
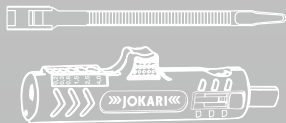
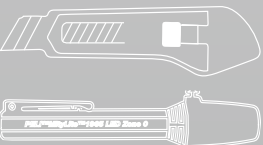
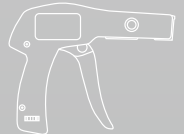
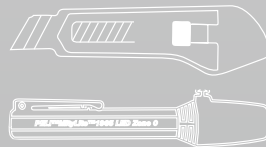
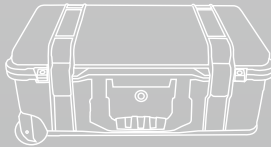
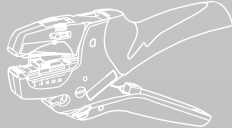
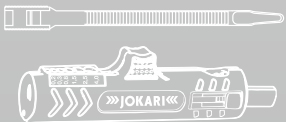
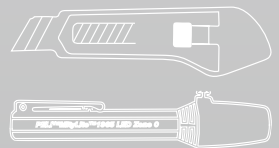
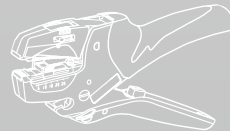
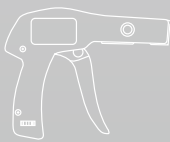
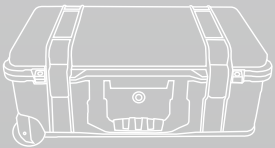
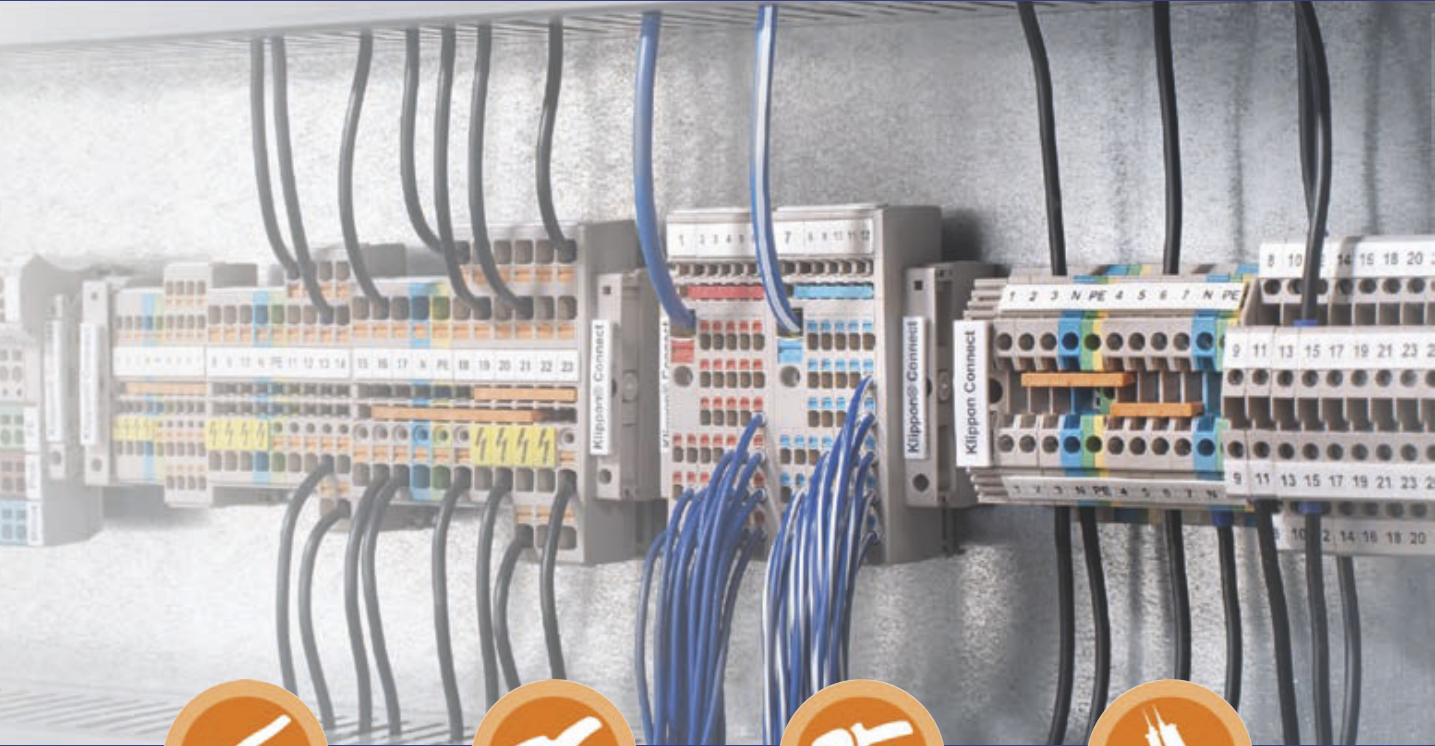

Schneiden, Abisolieren, Crimpen, Testen



Schneiden statt Quetschen

Entwickeln Sie Superkräfte beim Durchtrennen von Kupfer- und Aluminiumleitern. Mit unseren professionellen Schneidwerkzeugen arbeiten Sie so schnell und präzise wie noch nie. Selbst anspruchsvolle Schneidarbeiten erledigen Sie mühelos und ohne großen Kraftaufwand – unabhängig vom Leiterquerschnitt und der Installationsumgebung. Dafür sorgen optimal geformte Schneiden, durchdachte Mechanik und perfekte Ergonomie.



Abisolieren statt Abreißen

Verbinden Sie Schnelligkeit mit Fingerspitzengefühl. Unsere professionellen Abisolierwerkzeuge machen Ihnen die Arbeit leichter als je zuvor. Ganz gleich, ob Sie kleine oder große Leiterquerschnitte verarbeiten wollen: Sie erzielen immer ein perfektes und fehlerfreies Ergebnis. Das geht, weil sich unsere Abisolierwerkzeuge für verschiedene Isolationen und Leiterquerschnitte eignen – und weil Sie in unserem großen Angebot genau das Werkzeug finden, das genau zu Ihren Anforderungen passt

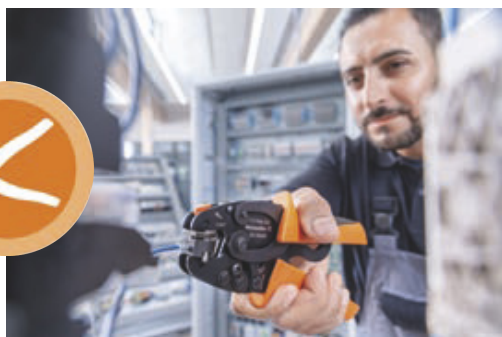

Crimpen statt Zerstören

Zuverlässige Crimpwerkzeuge, mit denen Sie Aderendhülsen und Kontakte ultraschnell verbinden. Machen Sie perfektes Crimpen zur Regel. Denn mit jeder wirklich dauerhaften Crimpverbindung machen Sie Anlagen zuverlässiger und sicherer. Außerdem sparen Sie unendlich viel Zeit bei der Installation. Vorausgesetzt Sie benutzen die hochwertigen Präzisions-Crimpwerkzeuge von Weidmüller. Damit stellen sie schnell und einfach perfekte Crimpverbindungen her, die nahezu ewig halten und allen internationalen Normen und Vorschriften entsprechen.



Testen statt Kurzschließen

Prüf- und Messergebnisse müssen in der Regel hundertprozentig korrekt ermittelt werden. Wir empfehlen Ihnen dafür die zuverlässigen Prüf- und Messwerkzeuge von Weidmüller. In unserem vollständigen Sortiment finden Sie passende Produkte für jede Leistungsanforderung und jeden Einsatzzweck. Von klassischen Spannungsprüfern über Strommesszangen bis hin zu Steckdosen- und FI-Testern.

Das Original - stripax®

Legendär seit 1976



50
JAHRE stripax®
1976 - 2026



Weitere Informationen unter
www.heinz-hesse-kg.de

Weidmüller 



Werkzeuge

Cut it. Strip it. Crimp it.

Mit den Profi-Werkzeugen von Weidmüller erledigen Sie Ihre Arbeit schneller, besser und präziser als je zuvor.



Mehr Informationen auf unserer Website:
www.weidmueller.de/werkzeuge

Weidmüller 



ÜBERSICHT



	KTmini	KT 8	KT 8S*	KT 12	KT 22	KT 40	KT 50
Maximale Schneidleistung - Kupferkabel							
eindrätig	16 mm ²	16 mm ²	16 mm ²	16 mm ²	25 mm ²		
mehrdrätig	16 mm ²	16 mm ²	16 mm ²	25 mm ²	50 mm ²	300 mm ²	400 mm ²
feindrätig	16 mm ²	16 mm ²	16 mm ²	35 mm ²	95 mm ²	300 mm ²	400 mm ²
Maximale Schneidleistung - Aluminiumkabel							
eindrätig	16 mm ²	16 mm ²	35 mm ²	25 mm ²	50 mm ²		
mehrdrätig	16 mm ²	16 mm ²	35 mm ²	25 mm ²	70 mm ²	300 mm ²	400 mm ²
Sektorleitung							
Kupfer	-	-	-	-	-	3 x 50 SM	4 x 70 SM
Daten-/Telefon-/Steuerkabel							
Durchmesser	Ø 7 mm	Ø 8 mm	Ø 8 mm	Ø 12 mm	Ø 22 mm	Ø 40 mm	Ø 50 mm
Werkzeugdaten							
Hesse-Art.-Nr.	480765	480778	480780	480779	480789	480761	480762
Weidmüller Nr.	2876460000	9002650000	2876450000	9002660000	1157830000	2993490000	2993500000
	NEU	GÄNGIG	NEU	GÄNGIG		GÄNGIG	
Länge (mm)	120	185	185	225	245	290	345
Gewicht (g)	91	180	220	300	460	740	1370
UVP in € zzgl. MwSt.	29,00	39,00	34,60	42,00	55,00	230,00	340,00

Weidmüller

Einhandschneider
swifty® CS Set



Hesse- Art.-Nr.	Modell Herstellernr.	Schneid- leistung	Länge (mm)	UVP in € zzgl. MwSt.
480910 NEU	swifty® CS Set 9006060000	Kupferkabel bis 1,5 mm ² eindrätig / 2,5 mm ² feindrätig	205	33,00

Weidmüller

Kabelmesser
Slicer 1K



Hesse- Art.-Nr.	Modell Herstellernr.	Länge (mm)	Gewicht (g)	UVP in € zzgl. MwSt.
480730	Slicer 1K 9918160000	110	89	24,70
480711	Slicer 2K 9041600000	120	159	46,80

Weidmüller

Spitzzange
SZE ESD 130



Hesse- Art.-Nr.	Modell Herstellernr.	Länge (mm)	Gewicht (g)	UVP in € zzgl. MwSt.
490562	SZE ESD 130 9204770000	130	90	67,40

Weidmüller

Seitenschneider
**SEE ESD 120/125
SVSE ESD 130**



Hesse- Art.-Nr.	Modell Herstellernr.	Länge (mm)	Gewicht (g)	UVP in € zzgl. MwSt.
490565	SEE ESD 120 9205130000	120	90	87,40
490564	SEE ESD 125 9204750000	125	125	80,30
490566	SVSE ESD 130 9205140000	120	90	98,80

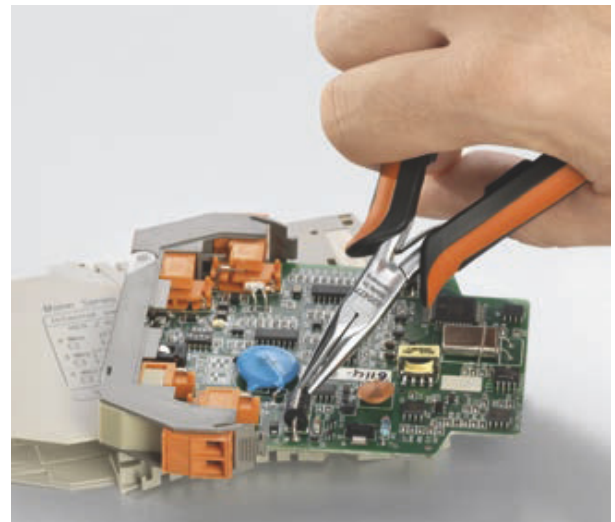

Weidmüller

Seitenschneider
Super Cut



Hesse- Art.-Nr.	Modell Herstellernr.	Länge (mm)	Gewicht (g)	UVP in € zzgl. MwSt.
498801 GÄNGIG	Super Cut 9205150000	128	51	39,00

Weidmüller

Ablängautomat
Cutfix Pro

Zum automatischen Ablängen von Einzelleitern bis 8 mm Durchmesser.

Hesse- Art.-Nr.	Modell Herstellernr.	Einzelleiter (mm ²)	Durchlass Max. ø (mm)	Längenvorwahl (mm)	UVP in € zzgl. MwSt.
482512 NEU	Cutfix Pro 2797190000	feindrätig: 10 eindrätig: 2,5	8	10 - 999,9	5.000,00









Ersatzmesser
auf Anfrage
lieferbar

Weidmüller 

Abisolier- und Schneidwerkzeug
stripax® (versch. Modelle)

Hesse- Art.-Nr.	Modell Herstellernr.	Abisolierbereich (mm ²)	Länge (mm)	UVP in € zzgl. MwSt.
480755 	M-D-stripax® 9001280000	0,08 - 1,0	135	80,00
480750 	stripax® 9005000000	0,08 - 10,0	190	94,00
480828 	stripax® 16 9005610000	6,0 - 16,0	190	150,00
480935 	stripax® UL 1468880000	0,25 - 6,0	190	115,00
480938	stripax® UL XL 1512780000	2,5 - 10,0	190	135,00
480776 	stripax® Plus 2.5 9020000000	0,5 - 2,5	210	215,40



stripax®



M-D-stripax®



stripax® UL



stripax® UL XL



stripax® Plus 2.5



Abisolierautomat
Powerstripper 6,0 

DIN VDE 0295.KL.5
Ersatzmesser AIMESA V - lieferbar (Hesse-Nr.: 482508)



Hesse- Art.-Nr.	Modell Herstellernr.	Abisolierbereich (mm ²)	Abisolierlänge (mm)	Leiterlänge (mm)	Leiterraufen ø (mm)	UVP in € zzgl. MwSt.
482506 	Powerstripper 6,0 9028510000	0,05 - 6,0 (~AWG 30-10)	3 - 20	22	Max. 5	2.600,00

Weidmüller

Sortiment stripax® Plus 2.5



H 0.5/14 H 0.75/14 H 1/14 H 1.5/14 H 2.5/14



Hesse- Art.-Nr.	Modell Herstellernr.	Bestückung	UVP in € zzgl. MwSt.
480969	Sortiment 9028780000	je 500 Stk. H 0,5/14D W BD, H 0,75/14D GR BD, H 1,0/14D R BD, H 1,5/14D SW BD, H 2,5/14D BL BD	395,00
481115	DIN H 0.5/14 9004280000	H0,5/14D weiß (500 Stk.)	7,90
481116	DIN H 0.75/14 9004300000	H0,75/14D grau (500 Stk.)	7,90
481117	DIN H 1/14 9004330000	H1,0x14D rot (500 Stk.)	7,90
481118	DIN H 1.5/14 9004350000	H1,5/14D schwarz (500 Stk.)	7,90
481126	DIN H 2.5/14 9004360000	H2,5/14D blau (500 Stk.)	9,20

Weidmüller

Abmantelwerkzeug AM 25 / 35 / X



AM X



AM 25

AM 35

Hesse- Art.-Nr.	Modell Herstellernr.	Abisolierbereich (mm Ø)	Länge (mm)	UVP in € zzgl. MwSt.
480783 GÄNGIG	AM 25 9001540000	6,0 - 25,0	135	49,00
480842 GÄNGIG	AM 35 9001080000	25,0 - 36,0	140	58,00
480874	AM X 2625720000	0 - 25,0	160	175,00

Weidmüller

Abisolier- und Schneidwerkzeug multi-stripax®



Hesse- Art.-Nr.	Modell Herstellernr.	Abisolierbereich (mm ²)	Länge (mm)	UVP in € zzgl. MwSt.
481121	multi-stripax® 0.75-4 ² SL 9203610000	0,75 - 4,0	250	377,70
480918	multi-stripax® 6-16 9202210000	6,0 - 16,0	260	377,70

Weidmüller

Abmantelwerkzeug AM 12 / 16



AM 12

AM 16

Hesse- Art.-Nr.	Modell Herstellernr.	Abisolierbereich (mm Ø)	Länge (mm)	UVP in € zzgl. MwSt.
480899	AM 12 9030060000	0,5 - 12,5	97	42,00
480902 GÄNGIG	AM 16 9204190000	6,0 - 17,3	53	80,00

Weidmüller

Abmantelwerkzeug CST-vario

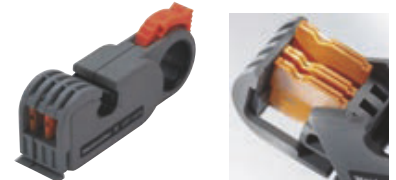

Hesse- Art.-Nr.	Modell Herstellernr.	Abisolierbereich (mm Ø)	Länge (mm)	UVP in € zzgl. MwSt.
480876 GÄNGIG	CST-vario 9005700000	2.5 - 8.0	116	110,00
480877	Messerhalter zu CST VARIO 9005740000	2,5 - 8,0	125	70,00
480852	CST 9030500000	2.5 - 8.0	100	86,00
480858	KASSETTE CST BLAU 9032020000	2.5 - 8.0	35	35,00
480859	KASSETTE CST GRÜN 9032000000	2.5 - 8.0	35	39,00
480860	KASSETTE CST BRAUN 9032010000	2.5 - 8.0	35	39,00













CRIMPEN



Weidmüller 

Crimpwerkzeug

PZ 2,5 S – PZ 50

Hesse-Art.-Nr.	Modell Herstellernr.	Abisolierbereich (mm ²)	Crimp- form	UVP in € zzgl. MwSt.
480774 NEU	PZ 2,5 S 2903690000	0,14 - 2,5		135,80
480771 GÄNGIG	PZ 3 0567300000	0,5 - 6,0		240,00
480770 GÄNGIG	PZ 4 9012500000	0,5 - 4,0		195,00
480811 GÄNGIG	PZ 6 ROTO 9014350000	0,14 - 6,0		210,00
480817 GÄNGIG	PZ 6 ROTO L 1444050000	0,14 - 6,0		210,00
480836	PZ 10 SQR 1445080000	0,14 - 10,0		236,00
480835 GÄNGIG	PZ 10 HEX 1445070000	0,25 - 10,0		236,00
480772 GÄNGIG	PZ 16 9012600000	6,0 - 16,0		210,00
480839	PZ ZH 16 9013600000	6,0/10,0/16,0		320,00
480775 GÄNGIG	PZ 50 9006450000	25,0/35,0/50,0		315,00

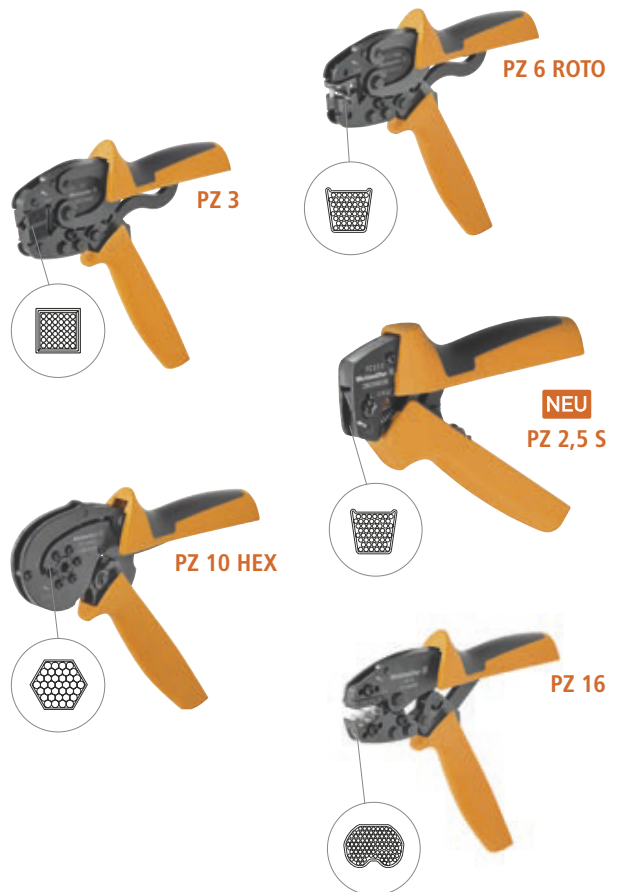



Weidmüller

Abisolier- und Crimpautomat **Crimpfix Eco**



Abisolier- und Crimpautomat für Aderendhülsen mit einer Hüslenlänge von 8 mm / Gesamthüslenlänge 14 mm.

Hesse- Art.-Nr.	Modell Herstellernr.	Abisolierbereich (mm ²)	AEH Hülsen ø (mm ²)	AEH-Länge (mm)	Crimpbereich (mm ²)	UVP in € zzgl. MwSt.
482509 NEU	Crimpfix Eco 2833890000	0,05 - 2,5 (~AWG 20-14)	0,5 - 2,5	14	0,5 - 2,5	7.550,00

Weidmüller

Aderendhülsen Großpack **Bandware (Farbcode DIN)**



H 0.5/14 H 0.75/14 H 1/14 H 1.5/14 H 2.5/14

Hesse- Art.-Nr.	Modell Herstellernr.	Bestückung	Farbe	VE (Stk.)	UVP in € zzgl. MwSt.
481992	DIN H 0,5/14D GR BD GSP 9005860000	H 0,5/14D weiß		5000	86,50
481993	DIN H 0,75/14D GR BD GSP 9005870000	H 0,75/14D grau		5000	86,50
481994	DIN H 1,0/14D R BD GSP 9005880000	H 1,0/14D rot		5000	86,50
481995	DIN H 1,5/14D SW BD GSP 9005890000	H 1,5/14D schwarz		5000	86,50
481996	DIN H 2,5/14D BL BD GSP 9005850000	H 2,5/14D blau		3000	86,50



Weidmüller

Crimpautomat **Powercrimper Vario**

Zur Verarbeitung von **isolierten Verbindern** entsprechend Kabelschuhen wie CTI 6G - Wechseleinsätze auf Anfrage.

Hesse- Art.-Nr.	Modell Herstellernr.	Crimpbereich (mm ²)	Crimplänge (mm)	Einführlänge (mm)	UVP in € zzgl. MwSt.
482510 NEU	Powercrimper Vario 3032890000	0,5 - 6,0	12	38	4.790,00

Crimpwerkzeug

Kabelschuhe isoliert/unisoliert

Hesse-Art.-Nr.	Modell Herstellernr.	Abisolierbereich (mm ²)	Crimpart	UVP in € zzgl. MwSt.
480810	HTI 15 9014400000	0,5 - 2,5	PVC- und Polyamid- isolierte Verbinder	211,10
480812	GÄNGIG CTI 6 G 9202850000	0,5 - 6,0	PVC- und Polyamid- isolierte Verbinder	230,00
480813	CTI 6 9006120000	0,5 - 6,0	PVC- und Polyamid- isolierte Verbinder	230,00
480830	HTN 21 9014610000	0,5 - 6,0	Nicht isolierte Kabel- schuhe und Verbinder	236,00
480814	HTN 21 M. AN 9014100000	0,5 - 6,0	Nicht isolierte Kabel- schuhe und Verbinder	210,00
480892	CTN 25 D 4 9006220000	10,0 - 25,0	Nicht isolierte Kabel- schuhe und Verbinder	400,00
480898	CTN 25 D 5 9006230000	10,0 - 25,0	Nicht isolierte Kabel- schuhe und Verbinder	400,00



Weidmüller

Crimpwerkzeug

Flachsteckverbinder

Hesse-Art.-Nr.	Modell Herstellernr.	Abisolierbereich (mm ²)	Crimpart	UVP in € zzgl. MwSt.
480807	HTF RSV 16 9013560000	0,14 - 1,5	Kontakte des RSV- und DSTV-HD-Systems	520,60
480802	HTF 28 9013090000	0,1 - 1,0	Flachsteckhülsen / Flachstecker	365,00
480804	HTF 48 9013080000	0,5 - 2,5	Flachsteckhülsen / Flachstecker	320,00
480806	HTF 63 9013400000	0,5 - 2,5	Flachsteckhülsen und Flachstecker	320,00
480901	CTX CM 1,6/2,5 9018490000	0,14 - 4	Gedrehte Stift- und Buchsenkontakte	410,00
480954	CTF 63 9202860000	0,5 - 6,0	Flachsteckhülsen und Flachstecker	457,50
480808	HTG 58-59 9012020000	2,0 - 10,0	Coaxial-Verbinder	259,10

Weidmüller

Crimpwerkzeug

versch. Modelle



Hesse-Art.-Nr.	Modell Herstellernr.	Abisolierbereich (mm ²)	Crimpart	UVP in € zzgl. MwSt.
480843	TT 864 RS 9008120000	0,5 - 2,5	Modulare Steckverbinder, System WE und DEC	286,00
480891	TT 1064 RS 9008190000	0,236 - 12,0		313,30
481405	PZ PK 6/70 1500470000	6,0 - 70,0	Presskabelschuhe, -verbinder etc.	349,70

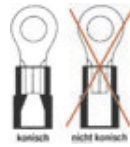

Weidmüller

Ringkabelverbinder LIR





Hesse- Art.-Nr.	Modell Herstellernr.	Querschnitt (mm ²)	Dimension	Farbe	VE (Stk.)	UVP in € zzgl. MwSt.
482102	LIR 1,5M3 V 9200070000	0,5 - 1,5	M3		100	6,00
482111	LIR 2,5M5 V 9200180000	1,5 - 2,5	M5		100	7,80
482117	LIR 6M6 V 9200250000	4,0 - 6,0	M6		100	15,30



Weidmüller



Stiftkabelverbinder LIP

Hesse- Art.-Nr.	Modell Herstellernr.	Querschnitt (mm ²)	Maße (mm)	Farbe	VE (Stk.)	UVP in € zzgl. MwSt.
482135	LIP 1,5R12 V 9200460000	0,5 - 1,5	L = 12		100	7,80
482136	LIP 2,5R12 V 9200470000	1,5 - 2,5	L = 12		100	8,60
482137	LIP 6R14 V 9200480000	4,0 - 6,0	L = 14		100	15,90



Weidmüller



Stoßverbinder LIB

Hesse- Art.-Nr.	Modell Herstellernr.	Querschnitt (mm ²)	Maße (mm)	Farbe	VE (Stk.)	UVP in € zzgl. MwSt.
482138	LIB 1,5B25 VF 9200490000	0,5 - 1,5	L = 24,5		100	9,30
482139	LIB 2,5B25 VF 9200500000	1,5 - 2,5	L = 24,5		100	10,50
482140	LIB 6B26 VF 9200510000	4,0 - 6,0	L = 26,0		100	16,20



Weidmüller

Flachsteckhülsen LIF

Hesse- Art.-Nr.	Modell Herstellernr.	Querschnitt (mm ²)	Maße (mm)	Farbe	VE (Stk.)	UVP in € zzgl. MwSt.
482143	LIF 1,5F638 R 9200540000	0,5 - 1,5	6,3 x 0,8		100	9,00
482145	LIF 2,5F638 R 9200560000	1,5 - 2,5	6,3 x 0,8		100	9,60
482146	LIF 6F638 R 9200570000	4,0 - 6,0	6,3 x 0,8		100	14,10



Weidmüller 

Sortiment

Kabelschuh-Set



Hesse- Art.-Nr.	Modell Herstellernr.	Abisolierbereich (mm ²)	Stückzahl	UVP in € zzgl. MwSt.
485788 GÄNGIG	Kabelschuh-Set 9202620000	0,5 - 6	600 Stk.	90,00



Weidmüller 

Sortiment

Crimpset Kontakte



Hesse- Art.-Nr.	Modell Herstellernr.	Inhalt (1.150-teilig in Raaco-Koffer)	UVP in € zzgl. MwSt.
485791	Crimpset Kontakte 9202640000	Ringkabelschuhe LIR / Stiftkabelschuhe LIP / Stoßverbinder LIB / Flachsteckhülsen LIF / AEH 0,5 - 6,0	350,00

Weidmüller 

Sortiment

Aderendhülsen-Set



Hesse- Art.-Nr.	Modell Herstellernr.	Abisolierbereich (mm ²)	Stückzahl	UVP in € zzgl. MwSt.
485789 GÄNGIG	Aderendhülsen-Set 9202630000	0,5 - 16	2.200 Stk.	82,90



SET PZ 6 roto L RC

Crimp-Set 4

Weidmüller 

Sortiment

Crimp Sortimente



Hesse- Art.-Nr.	Modell Herstellernr.	Abisolierbereich (mm ²)	Stückzahl	UVP in € zzgl. MwSt.
485803	SET PZ 6 roto L RC 1470940000	0,5 - 6	4.500 Stk.	295,00
480782	Crimp-Set 4 9025800000	0 - 4	3.050 Stk.	325,00

Weidmüller  by Hesse

Sortiment

AEH-/Kabelschuh-Mini



Hesse- Art.-Nr.	Modell Herstellernr.	Abisolierbereich (mm ²)	Stückzahl	UVP in € zzgl. MwSt.
485793	Kabelschuh-Set Mini 485793	0,5 - 6	180 Stk.	41,30
485794	AEH-Set Mini 485794	0,5 - 16	685 Stk.	46,60



Kabelschuh-Set Mini



AEH-Set Mini





TESTEN & SCHRAUBEN



Weidmüller 

Spannungsprüfer
VT



Hesse- Art.-Nr.	Modell Herstellernr.	Nennspannungs- bereich	Anzeige	UVP in € zzgl. MwSt.
480073 	VT Digi Pro 9918870000	1 – 1000 V AC/DC	digital LCD	116,00
480076 	VT Combi Pro 9918860000	6 – 690 V AC/DC	LED	81,10
480081 	VT Master 9918880000	12 – 690 V AC/DC	LED	51,60
480079 	VT 9918950000	12 – 690 V AC/DC	LED	26,40

Weidmüller 

Spannungsprüfer
VT CTB (KFZ)



Hesse- Art.-Nr.	Modell Herstellernr.	Arbeits- bereich (V)	Länge (mm)	UVP in € zzgl. MwSt.
480075 	VT CTB 9918970000	5 - 48	158	21,10

Weidmüller 



Spannungstester
VT CL



Hesse- Art.-Nr.	Modell Herstellernr.	Arbeits- bereich (V)	Länge (mm)	UVP in € zzgl. MwSt.
481108 	VT CL 2436660000	90 - 1000	155	20,00

Weidmüller 



Magnetfeldprüfer
VT M



Hesse- Art.-Nr.	Modell Herstellernr.	Schutzklasse	Länge (mm)	UVP in € zzgl. MwSt.
481144	VT M 2436680000	IP65	155	37,90

Weidmüller 

Spannungstester
SD ELEC Pro



Hesse- Art.-Nr.	Modell Herstellernr.	Abtrieb	Länge (mm)	UVP in € zzgl. MwSt.
481105 	SD ELEC Pro 2855000000	3,0	153	6,80

Weidmüller 

Multimeter

DMM 600 V / 1.000 V



DMM 600 V



DMM 1.000 V

Hesse- Art.-Nr.	Modell Herstellernr.	Arbeitsbereich	Strom- messwert (A)	Schutz- art	Gewicht (g)	UVP in € zzgl. MwSt.
480200 NEU	DMM 600 V 3113220000	1 mV - 600 V AC/DC, CAT III	max. 10 A	IP40	350	113,30
480201 NEU	DMM 1.000 V 3113230000	1mV - 1.000 V AC/DC, CAT III	max. 10 A	IP44	350	170,50



Weidmüller 

Multimeter

CCM 400 A



Hesse- Art.-Nr.	Modell Herstellernr.	Arbeitsbereich	Strom- messwert (A)	Schutz- art	Gewicht (g)	UVP in € zzgl. MwSt.
480202 NEU	CCM 400 A 3113240000	1mV - 1.000 V AC, CAT IV 1mV - 1.500 V DC, CAT III	max. 400 A	IP40	350	170,50

Weidmüller 

Schraubendreher

**SDIPM PZ2
plus/ minus**



Hesse- Art.-Nr.	Modell Herstellernr.	Maße Klinge (mm)	Gewicht (g)	UVP in € zzgl. MwSt.
481219	SDIPM PZ2 2749690000	218	78	13,80

Weidmüller 

Schraubwerkzeug

FleCaFix



Hesse- Art.-Nr.	Modell Herstellernr.	Schlüsselweite (mm)	Gewicht (g)	UVP in € zzgl. MwSt.
480905	FleCaFix 11-24 9015900000	11 - 24	190	95,00
480906	FleCaFix 24-36 9015980000	24 - 36	240	95,00

Weidmüller 

Schraubendrehersatz, 6-teilig

SDI/SD SET S2.5-5.5/PH1/2



Hesse- Art.-Nr.	Modell Herstellernr.	Inhalt (6-teilig)	UVP in € zzgl. MwSt.
481033 VDE	SDI SET S2.5-5.5/PH1/2 2749750000	SDIS 2,5 / 3,0 / 4,0 / 5,5 SDIK PH1 / PH2	32,00
481034	SD SET S2.5-5.5/PH1/2 2749200000	SDS 2,5 / 3,0 / 4,0 / 5,5 SDK PH1 / PH2	27,50

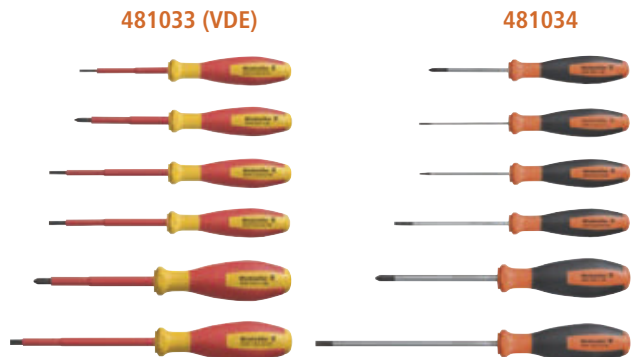

Weidmüller  by Hesse

Sortiment

WM Azubi Tasche



Hesse-Art.-Nr.	Modell Hersteller-nr.	Bestückung	Stückzahl	UVP in € zzgl. MwSt.
490018	WM Azubi Tasche 490018	stripax®, KT8, SD ELEC Pro, SDI SET	9-teilig, in Tasche	216,30



Weidmüller  by Hesse

Sortiment

Kabelverarbeitung

Hesse-Art.-Nr.	Modell Hersteller-nr.	Bestückung	Stückzahl	UVP in € zzgl. MwSt.
490136	Kabelverarbeitung 490136	stripax®, PZ6 roto ADJ, SD ELEC Pro	6-teilig, in L-Boxx	252,90

Weidmüller 

Schraubwerkzeug

SCREWTY®



Hesse-Art.-Nr.	Modell Hersteller-nr.	Arbeitsbereich	Gewicht (g)	UVP in € zzgl. MwSt.
480920	SCREWTY® M8 1900010000	M8	167	60,00
480950	SCREWTY® M12 GÄNGIG 1900000000	M12	139	60,00
480840	SCREWTY SET 1910000000	M8, M12, M8F, M12F	190	198,00
481041	SCREWTY M12 DM GÄNGIG 1900001000	M12 DM	268	185,00
481087	SCREWTY SET DM 1920000000	M8, M12, M8F, M12F	312	255,00
481043	SCREWTY M8 F 1900030000	M8 F	149	60,00

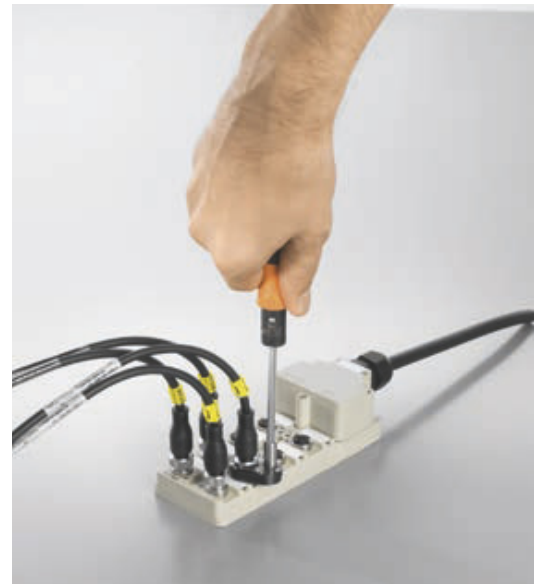

Weidmüller 

Werkzeugtasche

Pro Case Premium

Hesse-Art.-Nr.	Modell Hersteller-nr.	Ausstattung	Maße (mm)	UVP in € zzgl. MwSt.
480110	Pro Case leer 9202470000	leer	360 x 420 x 205	194,50
486282	Pro Case Premium 9202460000	29-teilig: KT8, stripax®, stripax® UL, PZ10 HEX, AM16, CTI 6 KBZ-180, FRZ- S-160, VT DIGI, VT CTL etc.)	170 x 480 x 400	1.401,40

NEU



Weidmüller 

Werkstattwagen

PVH Tool Chest Pro – leer PVH

Hesse- Art.-Nr.	Modell Herstellernr.	Ausstattung (leer)	UVP in € zzgl. MwSt.
482489 NEU	PVH Tool Chest Pro - leer PVH	894 x 526 x 928 mm + Anbautisch (485456) + Laptop Ablage (482494) + Holz Ablage (485458) + 7 Schubladen + 6 Kleinteile Fächer + Rollen	984,00



Weidmüller 

Werkstattwagen

PVH Tool Chest Pro – bestückt PVH

Hesse- Art.-Nr.	Modell Herstellernr.	Ausstattung (bestückt)	UVP in € zzgl. MwSt.
482457 NEU	PVH Tool Chest Pro - bestückt	894 x 526 x 928 mm 6 Schubladen 6 Kleinteile Fächer 4 Rollen + bestückte Schäume (s. S. 23)	5.200,00

Schaumeinlage, bestückt

TCB INL BIG 1 H

Hesse- Art.-Nr.	Modell Herstellernr.	Ausstattung (22-teilig)	UVP in € zzgl. MwSt.
482458 NEU	TCB INL BIG 1 H 3210210000	EDDING 8404 DEEP HOLE MARKER SD TO 0,6 x 3,0 mm SWIFTY SET FRZ S 200 KT 8 stripax® PZ 6 ROTO L CTI 6 SUPER CUT AM 16 Schaltschrankschlüssel 472 M 03 DMS PRO AKKU DMS PRO BIT E6,3 0,4x2,5x70 / 0,6x3,5x70 / 0x5,5x70 BIT E6,3 PZ1 / PZ2x70 BIT E6,3 T15 / T20 / T40x70	1.580,00



TCB INL THIRD 1 H
482461



TCB INL THIRD 2 H
482477



TCB INL THIRD 3
482465



TCB INL THIRD 3 H
482471



TCB INL THIRD 4 H
482502



TCB INL THIRD 7
482473



TCB INL THIRD 8
482475

Schaumeinlage, bestückt

TCB INL THIRD

Hesse- Art.-Nr.	Modell Herstellernr.	Ausstattung (7-teilig)	UVP in € zzgl. MwSt.
482461 NEU	TCB INL THIRD 1 H 3155240000	stripax® 16 PZ 16 PZ 2,5 CST-Vario Messerhalter zu CST-Vario	495,00
482477 NEU	TCB INL THIRD 2 H 3210230000	MULTIMETER C 2608	232,00
482465 NEU	TCB INL THIRD 3 3155260000	KT 22 PZ 50 AM 25 AM 35	550,00
482471 NEU	TCB INL THIRD 3 H 3210240000	SCREWTY SET SOCKET SET RT-1 FLECAFIX 11/24 FLECAFIX 24/36	515,00
482502 NEU	TCB INL THIRD 4 H 3210250000	Carry Lite 55 Koffer leer Phasenprüfer SD ELEC PRO Schraubendreher SDIK PH1 x 80 Schraubendreher SDIS 0,4 x 2.0 Schraubendreher SDIK PH2	370,00
482473 NEU	TCB INL THIRD 7 3155300000	VT M VT LCL VT DIGI PRO	210,00
482475 NEU	TCB INL THIRD 8 3155310000	DMM 1000 V	155,00

Crimpwerkzeug
**FLEXCRIMP
SET 5**

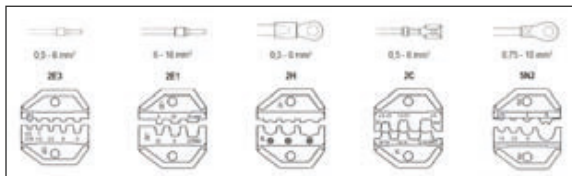

Hesse- Art.-Nr.	Modell Herstellernr.	Ausführung	UVP in € zzgl. MwSt.
485850	Flexcrimp Set 5 2723400000	Crimpwerkzeug mit 5 wechselbaren Crimpeinsätzen	168,00

Abisolier- und
Schneidwerkzeug

Strip 6





Ersatzmesser
passend zu Strip 6



Hesse- Art.-Nr.	Modell Herstellernr.	Ausführung	Abisolierbereich (mm²)	UVP in € zzgl. MwSt.
485723	Strip 6 9046200000	Feindrähtige u. massive Leiter mit PVC-Isolation	0,08 - 6,0	59,00
480751	MESZ SPX 2 6² 9005400000	Ersatzmesser passend zu Strip 6	-	33,00

Crimpwerkzeug
Crimp

Hesse- Art.-Nr.	Modell Herstellernr.	Typ	Abisolierbereich (mm²)	Crimp- form	UVP in € zzgl. MwSt.
485706	Crimp 6 Z 9046150000	Aderendhülsen nach DIN 45228 T.1+4	0,5 - 6,0		90,00
485707	Crimp 16 Z 9046080000	Aderendhülsen nach DIN 45228 T.1+4	6,0 / 10,0 / 16,0		90,00
485710	Crimp 6 i 9046130000	PVC- und Polyamid- isolierte Verbinder	0,5 - 6,0		95,00



Crimp 6 Z



Crimp 16 Z

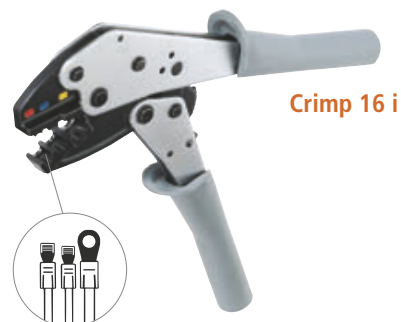

Crimp 6 i

»»» **JOKARI**®
original



60 Jahre **Kabelmesser**
Das Original seit 1966.

Erfunden von JOKARI.
Perfektioniert für Generationen.



Partner im Werkzeughandel
Heinz Hesse KG
www.heinz-hesse-kg.de



460628

460115

100%
MADE IN GERMANY
made by JOKARI

Super 4 plus

Secura 2K



Kabelmesser
No. 27/28H Secura



Hesse- Art.-Nr.	Modell Herstellernr.	Schneidleistung (mm ø)	Länge (mm)	UVP in € zzgl. MwSt.
460265	No. 27 Standard 10272	8,0 - 28,0	132	10,80
460065 GÄNGIG	No. 27 Secura 10270	8,0 - 28,0	132	14,80
460277	No. 28H Standard 10282	8,0 - 28,0	170	11,20
460075 GÄNGIG	No. 28H Secura 10280	8,0 - 28,0	170	15,60



Abisolierzange
versch. Modelle

Hesse- Art.-Nr.	Modell Herstellernr.	Abisolierbereich (mm ²)	Länge (mm)	UVP in € zzgl. MwSt.
460100 GÄNGIG	Super 4 plus 20050	0,2 - 6,0	165	21,90
460300 GÄNGIG	Super 4 Pro 20200	0,2 - 6,0	163	34,00
460104 GÄNGIG	Secura 2K 20100	0,2 - 6,0	200	45,00
460115 GÄNGIG	No. 6-16 ² 20090	6,0 - 16,0	166	84,10
460628 GÄNGIG	Sensor Special 20300	4,4 - 7,0	166	101,80
460629	Sensor Mini 20310	3,2 - 4,4	166	99,30



Kabelmesser
System 4-70



Hesse- Art.-Nr.	Modell Herstellernr.	Arbeitsbereich (mm)	Länge (mm)	UVP in € zzgl. MwSt.
460350 GÄNGIG	System 4-70 70000	8,0 - 35,0	167	39,80



Entmanteler
Secura Coaxi No. 1



Hesse- Art.-Nr.	Modell Herstellernr.	Schneidleistung (mm ø)	Länge (mm)	UVP in € zzgl. MwSt.
460122	Secura Coaxi No. 1	4,8 - 7,5	100	14,90
	GÄNGIG 30600			



Entmanteler
JOKARI XL



Hesse- Art.-Nr.	Modell Herstellernr.	Schneidleistung (mm ø)	Länge (mm)	UVP in € zzgl. MwSt.
460142	JOKARI XL 30125	8,0 - 13,0	176	22,50



Entmanteler
Secura No. 15



Hesse- Art.-Nr.	Modell Herstellernr.	Schneidleistung (mm ø)	Länge (mm)	UVP in € zzgl. MwSt.
460238	Secura No. 15 30155	8,0 - 13,0	124	33,50
	GÄNGIG			



Entmanteler
PV-Strip



Hesse- Art.-Nr.	Modell Herstellernr.	Schneidleistung (mm ²)	Länge (mm)	UVP in € zzgl. MwSt.
460256	PV-Strip 30195	2,5 - 6,0	124	34,90
460257	PV-Strip Pro 30199	1,5 - 16,0	130	42,60



Entmanteler
No. 1 Cat



Hesse- Art.-Nr.	Modell Herstellernr.	Schneidleistung (mm ø)	Länge (mm)	UVP in € zzgl. MwSt.
460121	No. 1 Cat 30500	4,5 - 10,0	100	29,00



Entmanteler
Universal No. 12/Strip No. 14



Hesse- Art.-Nr.	Modell Herstellernr.	Schneidleistung (mm ø)	Länge (mm)	UVP in € zzgl. MwSt.
460125	Universal No. 12 30120	8,0 - 13,0	124	14,80
	GÄNGIG			
460230	Strip No. 14 30140	4,0 - 13,0 (f. Flachkabel)	124	18,30



Entmanteler
PC-Strip



Hesse- Art.-Nr.	Modell Herstellernr.	Schneidleistung (mm ø)	Länge (mm)	UVP in € zzgl. MwSt.
460140	PC-Strip 30160	5,0 - 13,0	124	48,20



Entmanteler
Allrounder/Uni Plus



Hesse- Art.-Nr.	Modell Herstellernr.	Schneidleistung (mm ø)	Länge (mm)	UVP in € zzgl. MwSt.
460128	Allrounder 30900	4,0 - 15,0	130	19,30
	GÄNGIG			
460129	Uni Plus 30900	4,0 - 15,0	130	19,20
460229	Allrounder mit Locator-Box 30900 + 30910	4,0 - 15,0	-	40,70





Mikro-Präzisions-
werkzeug
PWS-PLUS



Hesse- Art.-Nr.	Modell Herstellernr.	Schneidleistung (mm ø)	Länge (mm)	UVP in € zzgl. MwSt.
460410 GÄNGIG	PWS-PLUS 002 40025	0,25 - 0,8	102	26,30
460418	ESD-Plus 002 40028	0,25 - 0,8	102	40,80



Kabelverarbeitungsset
4-70 in Box



Hesse- Art.-Nr.	Modell Herstellernr.	Schneidleistung (mm ø)	UVP in € zzgl. MwSt.
460353 GÄNGIG	4-70 in Box 71000	4,0 - 70,0	130,10



Jokari Sortiment
**No. 4 Pro/No.15/
No.1 Coaxi/L-Boxx**



Hesse- Art.-Nr.	Modell Herstellernr.	Umfang (3-teilig in L-Boxx)	UVP in € zzgl. MwSt.
490100 GÄNGIG	QUADRO Plus 490100	No. 4 Pro / Coaxi No. 1 SECURA No. 15	114,20



Kabelverarbeitungsset
QUADRO Plus



Hesse- Art.-Nr.	Modell Herstellernr.	Abisolierbereich (mm ²)	UVP in € zzgl. MwSt.
460242	QUADRO Plus 62000	0,5 - 2,5	318,30



Jokari Sortiment
**Jokari Azubi
Tasche**



Hesse- Art.-Nr.	Modell Herstellernr.	Umfang (4-teilig in Tasche)	UVP in € zzgl. MwSt.
490031	Jokari Azubi Tasche 490031	No. 28 H Secura No. 15 Secura / Super 4 Pro / Prüfer SD ELEC Pro	124,60

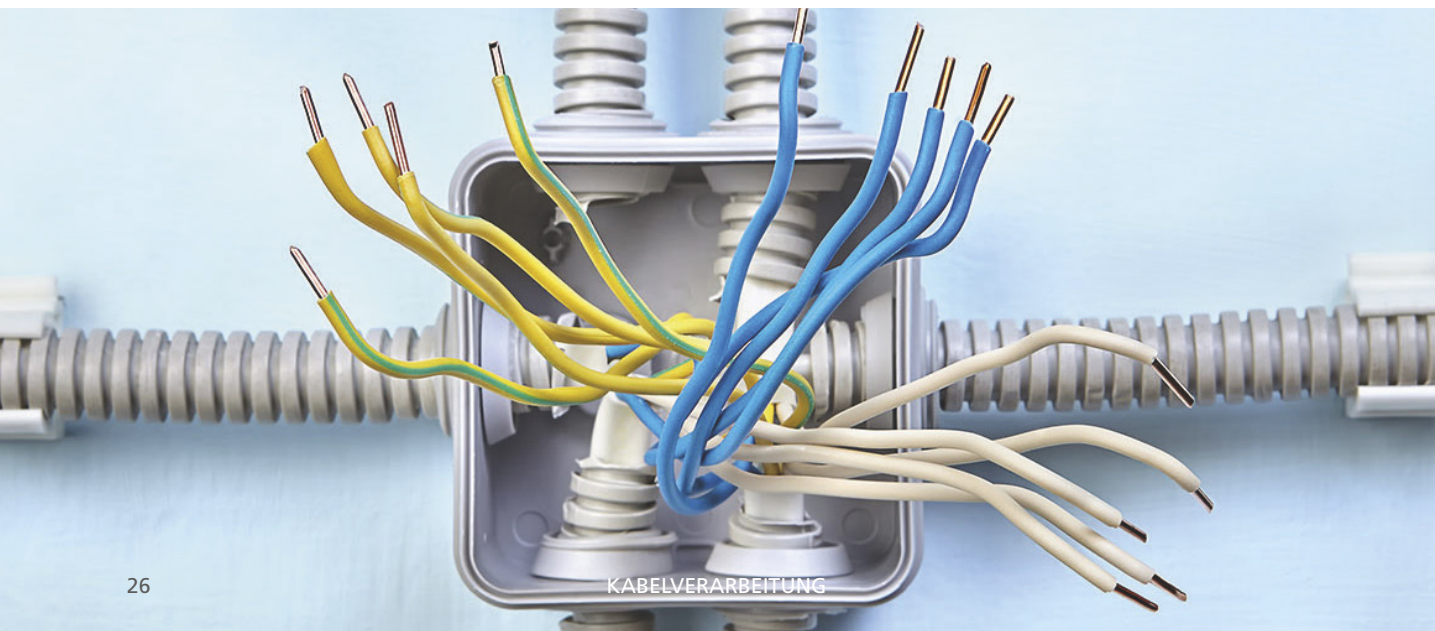

KABELFOTO / CABLE PICTURE	KABEL / CABLE	WERKZEUG / TOOL
	<p>NYM-J 3 x 1,5 mm² - 5 x 2,5 mm²</p>	 SECURA No. 15 30155
	<p>NHXMH-J 3 x 1,5 mm² - 5 x 2,5 mm²</p>	 SECURA No. 15 30155
	<p>NYY-J 3 x 1,5 mm² - 5 x 1,5 mm²</p>	 SECURA No. 15 30155
	<p>Erdkabel z.B. NAYY-J 4-70 mm Ø earth cable</p>	<p>Kabelmesser System 4-70 Set Cable Knife System 4-70 Set 71000</p> 
	<p>Koaxialkabel z.B. Kathrein LCD89, RG58/59 coaxial cable</p>	 SECURA Coaxi No. 1 30600
	<p>Netzwerkleitung Kat. 5 - Kat. 8 network cable Cat 5 - Cat 8</p>	 No.1-Cat 30500
	<p>Photovoltaikkabel z.B. H1Z2Z2-K 1x6 mm² all standard PV-cables</p>	 PV-Strip Pro 1,5 - 16 mm² 30199
	<p>Fernmeldeleitung z.B. J-Y(ST)Y 2 x 0,8 mm, Brandmeldekabel BMK J-Y(ST)Y 2x2x0,8 rot communication line</p>	 Sensor Special 20300
	<p>Steuerleitung z.B. Ölflex® Classic 110 3 x 1 mm² control wire</p>	 Sensor Special 20300

KABELFOTO / CABLE PICTURE	KABEL / CABLE	WERKZEUG / TOOL
	<p>Sensorleitung z.B. LiF9Y11Y-HF PUR 5 x 0,25 mm² 4,4 - 7 mm Ø sensor cable</p>	 <p>Sensor Special 20300</p> 
	<p>Sensorleitung z.B. Li9Y11Y-HF PUR 3 x 0,14 mm² 3,2 - 4,4 mm Ø sensor cable</p>	 <p>Sensor Mini 20310</p> 
	<p>Ho7 BQ-F 2 x 1,5 mm² - 5 x 2,5 mm²</p>	 <p>SECURA No. 15 30155</p> 
	<p>Ho7 RN-F 2 x 1,5 mm² - 5 x 2,5 mm²</p>	 <p>SECURA No. 15 30155</p> 
	<p>Einzelader z.B. Ho5V-K 1 x 2,5 mm² single core</p>	 <p>SECURA ≥K 20100</p> 
	<p>Einzelader z.B. Ho5V-K 1 x 1,5 mm² single core</p>	 <p>SECURA ≥K 20100</p> 
	<p>PVC-Leitung z.B. Ho7V-K 6-16 mm² PVC-wires</p>	 <p>No. 6-16² 20090</p> 
	<p>Flachkabel Twin & Earth 0,75-2,5 mm² max. 12 mm Breite flat cable</p>	 <p>FKZ Flachkabelzange Flat Cable Stripper 20030</p> 
	<p>AS-Interface Leitungen PUR, TPE, FR-PUC AS-Interface wires</p>	 <p>AS-Interface Pro 20075</p> 



SPECIAL MATERIALS



Super-UV-Schutz, mit erhöhter Widerstandsfähigkeit
POLYAMID 6.6 (UL94:HB), VERBESSERTE UV-BESTÄNDIGKEIT FÜR MEHR STABILITÄT UNTER ÄUSSERSTEN BEDINGUNGEN. IDEAL FÜR DEN EINSATZ IN KRITISCHEN ANWENDUNGEN



UV-beständige Kabelbinder
SCHWARZES UV-STABILISIERTES POLYAMID 6.6 (UL94:V2) - SELBSTLÖSCHEND



Hitzebeständige Kabelbinder
POLYAMID 6.6 (UL94:V2) NATUR UND SCHWARZ GARANTIERTE MAXIMALE EINSATZTEMPERATUR: +105°C. SELBSTLÖSCHEND



Kälte beständige Kabelbinder
DIE KABELBINDER AUS POLYAMID 6.6 (UL94:HB) BESITZEN EINE HOHE BESTÄNDIGKEIT GEGEN NIEDRIGE TEMPERATUREN. DAS PRODUKT IST UV-BESTÄNDIG



Selbstlöschende Kabelbinder
DIE SELBSTVERLÖSCHENDEN KABELBINDER AUS POLYAMID 6.6 (UL94:V0) SIND NICHT FLAMMVERBREITEND



Fluoreszierende Kabelbinder
AUS LEUCHTENDEM POLYAMID 6.6 HERGESTELLT. GEEIGNET FÜR INNENRÄUME UND IM ALLGEMEINEN ZU SICHERHEITZWECKEN

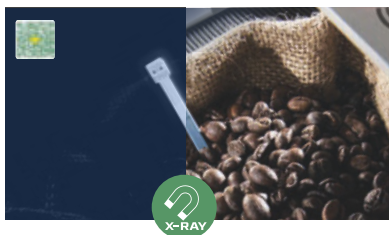

Detektierbare Kabelbinder
KABELBINDER AUS POLYAMID 6.6 KÖNNEN VON METALLDETEKTOREN UND RÖNTGENSTRAHLGERÄTEN DETEKTIERT WERDEN



Chemikalienbeständige Kabelbinder
KABELBINDER AUS POLYPROPYLEN (UL94:HB) SIND GEGEN AGGRESSIVE CHEMISCHE UMGEBUNGEN UND SÄUREN BESTÄNDIG



Farbige Kabelbinder
UNSERE KABELBINDER AUS POLYAMID 6.6 SIND IN EINER UMFANGREICHEN FARBAUSWAHL VERFÜGBAR



1



Zertifizierte Qualität für die Industrie



C RU US



Underwrites Laboratories of the USA



TÜV Süd



Rina



DNG-GL



Bureau Veritas



Lloyd's Register

Sapi Kabelbinder-Sortiment

Hergestellt aus halogen- und silikonfreiem POLYAMID 6.6. Hohe Flexibilität auch bei starken Temperaturschwankungen. Überdurchschnittlich farbbeständig (farbecht). Weitgehend chemikalienbeständig. Selbstlöschend entsprechend der Norm UL94 V2 POLYAMID innerhalb von max. 30 Sekunden.

Vom Rohstoff zum fertigen Produkt: Streben nach Exzellenz

100% MADE IN ITALY

Produktionszyklus von SapiSelco – Von der Verarbeitung des Rohmaterials bis zur Herstellung des Endprodukts durch Spritzgießen, findet ausschließlich in unseren Produktionsstätten in Italien statt.



Wie SapiSelco arbeitet



Spritzgußformen selbst entworfen und hergestellt



Qualität und Sicherheit Kundenzufriedenheit und den Schutz des Teams und der Umwelt zu gewährleisten



Analyse und Entwicklung Rohstoffe und Fertigprodukte für optimale Leistung



Eine aufmerksame Lieferkette zur Kontrolle und Verbesserung der Prozesse



Kabelbinder aus Polyamid 6.6

SEL.FIT

SELFIT®



Hesse- Art.-Nr.	Modell Herstellernr.	Farbe	Breite (mm)	Länge (mm)	Bündel (ø mm)	Öffnungsmoment (N/kg)	VE	UVP in € zzgl. MwSt.	
491007	SEL.2.202	natur	2,5	100	24	80 / 8	100	1,30	GÄNGIG
491010	SEL.2.203R	natur	2,5	135	35	80 / 8	100	2,60	
491011	SEL.2.204	natur	2,5	160	42	80 / 8	100	3,40	
491012	SEL.2.205	natur	2,5	200	55	80 / 8	100	3,40	GÄNGIG
491022	SEL.2.210	natur	3,5	140	36	180 / 18	100	3,00	GÄNGIG
491027	SEL.2.211	natur	3,5	200	55	180 / 18	100	3,80	
491032	SEL.2.212	natur	3,5	280	80	180 / 18	100	5,50	
491035	SEL.2.214	natur	3,5	360	103	180 / 18	100	11,00	
491033	SEL.2.221R	natur	4,5	160	38	220 / 22	100	5,10	
491034	SEL.2.222	natur	4,5	180	45	220 / 22	100	5,10	GÄNGIG
491042	SEL.2.223	natur	4,5	200	51	220 / 22	100	5,10	GÄNGIG
491047	SEL.2.425	natur	4,5	280	76	220 / 22	100	7,20	GÄNGIG
491048	SEL.2.426	natur	4,5	360	101	220 / 22	100	9,30	GÄNGIG
491043	SEL.2.427	natur	4,5	380	110	220 / 22	100	11,80	GÄNGIG
491049	SEL.2.428	natur	4,5	430	123	220 / 22	100	17,70	
491050	SEL.2.447	natur	6,0	360	101	400 / 40	100	20,60	
491052	SEL.2.430	natur	7,5	180	44	540 / 54	100	14,80	
491051	SEL.2.433	natur	7,5	280	76	540 / 54	100	17,70	
491060	SEL.2.434	natur	7,5	360	101	540 / 54	100	18,50	GÄNGIG
491063	SEL.2.435	natur	7,5	450	130	540 / 54	100	29,00	
491064	SEL.2.437	natur	7,5	540	160	540 / 54	100	34,50	GÄNGIG
491066	SEL.2.441	natur	7,5	750	222	540 / 54	100	51,30	
491069	SEL.2.142	natur	9,0	550	160	720 / 72	100	53,00	
491071	SEL.2.143	natur	9,0	780	235	720 / 72	100	70,60	
491072	SEL.2.156	natur	9,0	1330	409	720 / 72	100	134,10	
491085	SEL.2.457	natur	12,5	360	101	1.080 / 108	50	24,00	NEU
491073	SEL.2.451R	natur	12,5	500	222	1.080 / 108	2 x 50	63,90	
491077	SEL.2.453R	natur	12,5	1000	300	1.080 / 108	2 x 50	119,80	



Hesse- Art.-Nr.	Modell Herstellernr.	Farbe	Breite (mm)	Länge (mm)	Bündel (ø mm)	Öffnungsmoment (N/kg)	VE	UVP in € zzgl. MwSt.	
491092	SEL.3.202	schwarz	2,5	100	24	80 / 8	100	1,30	GÄNGIG
491091	SEL.3.203R	schwarz	2,5	135	35	80 / 8	100	2,60	GÄNGIG
491093	SEL.3.205	schwarz	2,5	200	55	80 / 8	100	3,40	GÄNGIG
491097	SEL.3.210	schwarz	3,5	140	36	180 / 18	100	3,00	GÄNGIG
491098	SEL.3.211	schwarz	3,5	200	55	180 / 18	100	3,80	GÄNGIG
491099	SEL.3.212	schwarz	3,5	280	80	180 / 18	100	5,50	GÄNGIG
491101	SEL.3.214	schwarz	3,5	360	103	180 / 18	100	11,00	
491039	SEL.3.222	schwarz	4,5	180	45	220 / 22	100	5,10	GÄNGIG
491111	SEL.3.223	schwarz	4,5	200	51	220 / 22	100	5,10	GÄNGIG
491112	SEL.3.425	schwarz	4,5	280	76	220 / 22	100	7,20	GÄNGIG
491113	SEL.3.426	schwarz	4,5	360	101	220 / 22	100	9,30	GÄNGIG
491118	SEL.3.427	schwarz	4,5	380	110	220 / 22	100	11,80	
491115	SEL.3.430	schwarz	7,5	180	44	540 / 54	100	14,80	
491116	SEL.3.433R	schwarz	7,5	280	76	540 / 54	100	17,70	
491117	SEL.3.434	schwarz	7,5	360	101	540 / 54	100	18,50	GÄNGIG
491119	SEL.3.435	schwarz	7,5	450	130	540 / 54	100	29,00	GÄNGIG
491114	SEL.3.437	schwarz	7,5	540	160	540 / 54	100	34,50	GÄNGIG
491120	SEL.3.441	schwarz	7,5	750	222	540 / 54	100	51,30	GÄNGIG
491121	SEL.3.142	schwarz	9,0	550	160	720 / 72	100	53,00	
491122	SEL.3.156	schwarz	9,0	1330	409	720 / 72	100	134,10	
491087	SEL.3.457	schwarz	12,5	360	101	720 / 72	50	24,00	NEU
491123	SEL.3.451R	schwarz	12,5	500	222	1.080 / 108	2 x 50	63,90	
491125	SEL.3.452	schwarz	12,5	750	300	1.080 / 108	2 x 50	99,60	
491124	SEL.3.453	schwarz	12,5	1000	300	1.080 / 108	2 x 50	119,80	



Hesse- Art.-Nr.	Modell Herstellernr.	Farbe	Breite (mm)	Länge (mm)	Bündel (ø mm)	Öffnungsmoment (N/kg)	UVP in € zzgl. MwSt.
491178	SEL.11.202R	blau	2,5	100	24	80 / 8	1,70
491024	SEL.11.210R	blau	3,5	140	36	180 / 18	3,80
491028	SEL.10.425R	rot	4,5	280	76	220 / 22	9,70
491045	SEL.14.425R	gelb	4,5	280	76	220 / 22	9,70





Kabelbinder mit Schraubenhalterung

OCH-SERIE



Hesse- Art.-Nr.	Modell Herstellernr.	Farbe	Breite (mm)	Bündel ø (mm)	Öffnungsmoment (N/kg)	VE (Stk.)	UVP in € zzgl. MwSt.
491334	OCH.3.2123R	schwarz	4,5 x 200	51	220 / 22	100	11,80



Kabelbinder als Kunststoffschelle

COL-SERIE



Hesse- Art.-Nr.	Modell Herstellernr.	Farbe	Breite (mm)	Bündel ø (mm)	Öffnungsmoment (N/kg)	VE (Stk.)	UVP in € zzgl. MwSt.
491062	COL.3.421	schwarz	9,0 x 265	15-63	400 / 40	100	27,20
491065	COL.3.422	schwarz	9,0 x 360	25-93	400 / 40	100	38,50



Kabelbinder, lösbar

RID



RID



Hesse- Art.-Nr.	Modell Herstellernr.	Farbe	Breite (mm)	Bündel ø (mm)	Öffnungsmoment (N/kg)	VE (Stk.)	 UVP in € zzgl. MwSt.
491146	RID.3.212	schwarz	3,5 x 280	80	180 / 18	100	130 7,20



Sicherungsplomben

SPY



Hesse- Art.-Nr.	Modell Herstellernr.	Farbe	Breite (mm)	Beschreibung	VE (Stk.)	UVP in € zzgl. MwSt.
491168	SPY.P14.002	gelb	6,6 x 300	Mit fortlaufender Nummerierung	300	85,30

Kabelbinder, detektierbar

DET



Hesse- Art.-Nr.	Modell Herstellernr.	Farbe	Breite (mm)	Bündel ø (mm)	Öffnungsmoment (N/kg)	VE (Stk.)	 UVP in € zzgl. MwSt.
491036	DET.11.2123R	blau	4,5 x 200	51	200 / 20	100	100 20,60

Sortiment

Kabelbinder-Sortiment, 1500-teilig

Hesse- Art.-Nr.	Modell Herstellernr.	Größe	Stückzahl	UVP in € zzgl. MwSt.
491134	Kabelbinder-Sortiment, 1500-teilig in 3,8l Eimer 105-120RP	2,5 x 100 mm	2x 100 Stk. natur	31,60
			2x 100 Stk. schwarz	
		3,5 x 140 mm	2x 100 Stk. rot	
			2x 100 Stk. blau	
			2x 100 Stk. gelb	
			3x 100 Stk. natur 2x 100 Stk. schwarz	



Sortiment

Kabelbinder-Sortiment, 1000-teilig

Hesse- Art.-Nr.	Modell Herstellernr.	Größe	Stückzahl	UVP in € zzgl. MwSt.
491131	Kabelbinder-Sortiment, 1000-teilig in 10,8l Eimer 105-200RP	4,5 x 200 mm	2x 100 Stk. natur	51,20
			2x 100 Stk. schwarz	
		4,5 x 280 mm	1x 100 Stück rot	
			1x 100 Stück grün	
			2x 100 Stück natur 2x 100 Stück schwarz	

Praktisch & kompakt

Kabelbinder-Wanddisplay

Hesse- Art.-Nr.	Modell Herstellernr.	Größe	Stückzahl	UVP in € zzgl. MwSt.
491189	Sapi Kabelbinder- Wanddisplay, 600-teilig SELFIT SERIE, gemischt und ClickTie	3,5 x 140 mm	1x 100 Stk. blau	119,40
		3,5 x 140 mm	1x 100 Stk. natur	
		4,5 x 200 mm	1x 100 Stk. natur	
		4,5 x 280 mm	1x 100 Stk. natur	
		7,5 x 360 mm	1x 100 Stk. natur	
		3,8 x 240 mm	1x 100 Stk. rot (ClickTies)	



Hesse- Art.-Nr.	Modell Herstellernr.	Größe	Stückzahl	UVP in € zzgl. MwSt.
491198	Sapi Kabelbinder- Wanddisplay, 600-teilig SELFIT SERIE, natur	2,5 x 100 mm	1x 100 Stk. natur	99,60
		2,5 x 200 mm	1x 100 Stk. natur	
		3,5 x 140 mm	1x 100 Stk. natur	
		3,5 x 200 mm	1x 100 Stk. natur	
		4,5 x 280 mm	1x 100 Stk. natur	
		4,5 x 360 mm	1x 100 Stk. natur	

Hesse- Art.-Nr.	Modell Herstellernr.	Größe	Stückzahl	UVP in € zzgl. MwSt.
491237	Sapi Kabelbinder- Wanddisplay, 600-teilig SELFIT SERIE, schwarz	2,5 x 100 mm	1x 100 Stk. schwarz	99,60
		2,5 x 200 mm	1x 100 Stk. schwarz	
		3,5 x 140 mm	1x 100 Stk. schwarz	
		3,5 x 200 mm	1x 100 Stk. schwarz	
		4,5 x 280 mm	1x 100 Stk. schwarz	
		4,5 x 360 mm	1x 100 Stk. schwarz	



Sapi Klebesockel-Set



Hesse- Art.-Nr.	Modell Herstellernr.	Inhalt	UVP in € zzgl. MwSt.
491300	Sapi Klebesockel-Set in Tayg Sortimentbox, 350-teilig 105-350KS	<ul style="list-style-type: none"> - 100x SELFIT-Kabelbinder 3,5 x 150 mm, schwarz - 100x SELFIT-Kabelbinder 4,5 x 200 mm, schwarz - 20x Befestigungssockel ø 27,5 mm, rund, schwarz, schraubbar - 10x Hakehalterung 26 x 13 mm, schwarz, Kabel bis ø 10 mm - 20x Befestigungssockel 30 x 15 x 12 mm, schwarz, schraubbar - 50 x Klebesockel 19 x 19 mm, schwarz, viereckig, selbstklebend - 50 x Klebesockel 27 x 27 mm, schwarz, viereckig, selbstklebend 	29,00

Befestigungssockel

Selbstklebende Montagesockel

	Hesse- Art.-Nr.	Modell Herstellernr.	Beschreibung	VE (Stk.)		UVP in € zzgl. MwSt.
	491133	BAS.2MT.507	Selbstklebende Montagesockel viereckig 19 x 19 mm - weiß - aus POLYAMID und paarweisem Klebeband. Der zweiseitige Klebestreifen erleichtert die manuelle Loslösung und das Anbringen des einzelnen Klebesockels.	100	30	19,80
 Ø 4 mm	491161	BAS.3MT.507	Selbstklebende Montagesockel viereckig 19 x 19 mm - schwarz - aus POLYAMID und paarweisem Klebeband. Der zweiseitige Klebestreifen erleichtert die manuelle Loslösung und das Anbringen des einzelnen Klebesockels.	100	30	19,80
	491136	BAS.2MT.508	Selbstklebende Montagesockel viereckig aus POLYAMID 27 x 27 mm - weiß - und paarweisem Klebeband. Der zweiseitige Klebestreifen erleichtert die manuelle Loslösung und das Anbringen des einzelnen Klebesockels.	100	30	26,10
 Ø 4,5 mm	491158	BAS.3MT.508	Selbstklebende Montagesockel viereckig aus POLYAMID 27 x 27 mm - schwarz - und paarweisem Klebeband. Der zweiseitige Klebestreifen erleichtert die manuelle Loslösung und das Anbringen des einzelnen Klebesockels.	100	30	26,10
	491157	SSC.3.2101	Sapi Befestigungssockel ø 27,5 mm, rund, schwarz , schraubbar. Für Nagelgeräte.	100	15	31,10
	491175	SUP.3.401	Sapi Befestigungssockel 30 x 15 x 12 mm, schwarz , schraubbar	100	30	7,60
	491173	GAN.3MT.402	Hakenhalterung 26 x 13 mm, schwarz , Kabel bis ø 10 mm	100	30	35,80



Kabelbinderschere

PIN.005

Hesse- Art.-Nr.	Modell Herstellernr.	Farbe	Max. Kabelbinder- bereich (mm)	Gewicht (g)	UVP in € zzgl. MwSt.
491132	PIN.005	silber	9,0	230	32,80

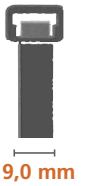

Kabelbinderschere

PIN.009

Hesse- Art.-Nr.	Modell Herstellernr.	Farbe	Max. Kabelbinder- bereich (mm)	Gewicht (g)	UVP in € zzgl. MwSt.
491190	PIN.009	rot	2,5 - 12,5	100	27,80

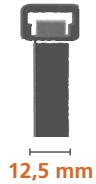

Kabelbinderzange

PIN.010



In L-Boxx mini
inkl. Schaumstoff
geliefert



4,8 mm



Hesse- Art.-Nr.	Modell Herstellernr.	Farbe	Max. Kabelbinder- bereich (mm)	Gewicht (g)	UVP in € zzgl. MwSt.
491319	PIN.010	schwarz/grün	2,5 - 4,8	230	118,00

GÄNGIG



PES-310 / 4 mm



Kabeleinziehband

PES

Hesse- Art.-Nr.	Hersteller Art.-Nr.	Farbe	Durchmesser (mm)	Länge (m)	Preis in € zzgl. MwSt.
460790	PES-310	natur	4	10	8,50
460792	PES-315	natur	4	15	9,30
460807	PES-320	natur	4	20	12,10
486100	70400030 GR	schwarz	4	30	126,00

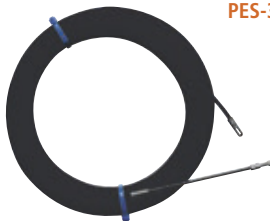

70400030 GR / 4 mm

Verarbeitungswerkzeuge für Kabelbinder EVO7i/EVO9i.

Anziehen und präzises Abschneiden mit geringem Kraftaufwand.

MADE FOR REAL 





HellermannTyton

Kabelbinderschere

EVOcut

Hesse-Art.-Nr.	Modell Herstellernr.	Max. Kabelbin-derbreite (mm)	Gewicht (g)	UVP in € zzgl. MwSt.
486050	EVOcut 110-05105	2,0 - 7,8	140	213,30



HellermannTyton

Kabelbinde-
zange

EVO7i



110-77001

Hesse-Art.-Nr.	Modell Herstellernr.	Max. Kabelbin-derbreite (mm)	Zugkraft (N)	UVP in € zzgl. MwSt.
486036 GÄNGIG	EVO7i 110-77001	2,5 - 4,8	18 - 165	453,50
486066	EVO7i SP 110-77002	2,5 - 4,8	18 - 165	590,60

HellermannTyton

Kabelbinde-
zange

EVO9i



710-00104

Hesse-Art.-Nr.	Modell Herstellernr.	Max. Kabelbin-derbreite (mm)	Zugkraft (N)	UVP in € zzgl. MwSt.
486067 GÄNGIG	EVO9i 110-88001	2,5 - 13,5	53 - 309	559,70
486068	EVO9i SP 110-88002	2,5 - 13,5	53 - 309	631,30

HellermannTyton

Kabelbinde-
zange

MK9SST



Für
Metall-
kabel-
binde-
r

Hesse-Art.-Nr.	Modell Herstellernr.	Max. Kabelbin-derbreite (mm)	Zugkraft (N)	UVP in € zzgl. MwSt.
485721	MK9SST 110-95000	16,0	Stufenlos einstellbar	1.128,20

HellermannTyton

Dreidornzange

3.3/3.7-PA-BK



Hesse-Art.-Nr.	Modell Herstellernr.	Bündel ø (mm)	Gewicht (g)	UVP in € zzgl. MwSt.
485683	3.3-PA-BK 621-30000	1,2 - 7,5	102	137,90
485762	3.7-PA-BK 621-30002	2,5 - 12	108	142,20

HellermannTyton

Doppelter Verschlusskopf zur Parallelbündelung

Kabelbinder SpeedyTie

Hesse- Art.-Nr.	Modell Herstellernr.	Farbe	Länge (mm)	Breite (mm)	Bündel Ø (mm)	VE (Stk.)	UVP in € zzgl. MwSt.
485700 GÄNGIG	SpeedyTie 115-00001	gelb	750	13	210	5	8,60



1

HellermannTyton

Doppelter Verschlusskopf zur Parallelbündelung

Kabelbinder SOFTFIX



Hesse- Art.-Nr.	Modell Herstellernr.	Farbe	Länge (mm)	Breite (mm)	Bündel Ø (mm)	VE (Stk.)	UVP in € zzgl. MwSt.
485699 GÄNGIG	XS 115-07190	schwarz	180	7	45	16	14,00
485738 NEU	XS 115-07269	schwarz	180	7	45	50	57,80
485698	S 115-07269	schwarz	260	7	70	12	18,40
485697 GÄNGIG	M 115-11270	schwarz	260	11	65	8	15,80
485679 GÄNGIG	L 115-07190	schwarz	340	11	90	6	13,80
485678 GÄNGIG	XL 115-28590	schwarz	580	28	150	3	22,60
485677	XXL 115-28898	schwarz	880	28	240	3	56,20

HellermannTyton

Kabelbinder aus Klett

Textie L

Hesse- Art.-Nr.	Modell Herstellernr.	Maße (mm)	Bündel Ø (mm)	VE (Stk.)	UVP in € zzgl. MwSt.
499763	Textie L 130-00019	330 x 12,5	116	10	21,70



HellermannTyton

Klebesockel / Isolierband

FMB4APT-I / HelaTape

Flex/Klebesockel



151-01527



710-00104



710-10602

Hesse- Art.-Nr.	Modell Herstellernr.	Farbe	Maße (mm)	UVP in € zzgl. MwSt.
486045 NEU	FMB4APT-I 151-01527	schwarz	28 x 28	241,30
486292	HTAPE-FLEX15 710-00104	schwarz	0,15 mm x 15 mm x 10 m	1,50
486352 VDE	HTAPE-FLEX1000+ 710-10602	schwarz	0,18 mm x 19 mm x 20 m PVC	15,80

HellermannTyton

Heißluftgebläse/Patrone
CHG900/P445



Hesse- Art.-Nr.	Modell Herstellernr.	Betriebstem- peratur (°C)	Gewicht (g)	UVP in € zzgl. MwSt.
485550	CHG900 391-90010	190 - 900	547	290,50
485502	P445 (Gaspatrone) 391-90101	-	115	18,20



HellermannTyton

Schrumpfschlauch-Set
ShrinkKit 321 Universal



Hesse- Art.-Nr.	Modell Herstellernr.	Schrumpfrate	Inhalt	UVP in € zzgl. MwSt.
485807	ShrinkKit 321 Universal 380-03002	3:1	975-teilig	160,40
485808	ShrinkKit 321A Universal mit Innenkleber 380-03003	3:1	385-teilig	170,90

HellermannTyton

Schrumpfschlauch-Set
ShrinkKit 321 Basic



Hesse- Art.-Nr.	Modell Herstellernr.	Schrumpfrate	Inhalt	UVP in € zzgl. MwSt.
485806	ShrinkKit 321 Basic 380-03001	3:1	220-teilig	37,40
GÄNGIG				
485821	ShrinkKit 321 A Basic mit Innen- kleber 380-03004	3:1	130-teilig	60,00
NEU				

HellermannTyton

Wärmeschrumpfschlauch Rollenware
HIS-3 / TCN20



TCN20



Hesse- Art.-Nr.	Modell Herstellernr.	Innen Ø (mm)	Innen Ø nach Schrumpfung (mm)	Wand- stärke (mm)	Länge (m)	UVP in € zzgl. MwSt.
485687	HIS, 3:1 (3/1 mm) 308-30300	3	1	0,55	10	39,70
485688	HIS, 3:1 (6/2 mm) 308-30600	6	2	0,65	5	39,70
485689	HIS, 3:1 (9/3 mm) 308-30900	9	3	0,75	5	39,70
485690	HIS, 3:1 (12/4 mm) 308-31200	12	4	0,8	5	39,70
485691	HIS, 3:1 (18/6 mm) 308-31800	18	6	0,9	4	39,70
485692	HIS, 3:1 (24/8 mm) 308-32400	24	8	1,2	3	39,70
485927	TCN20 (25,4/12,7 mm) 300-73100	25,4	12,7	0,85	60	632,65



DIE ROLL..PROFI BESTSELLER – SO STANDHAFT WIE FLEXIBEL.



ORIGINAL

Hesse-Nr.: 495000



FLEXIPASS

Hesse-Nr.: 495012



MINILIFT

Hesse-Nr.: 495015

1 Roll..Profi

Kabeltrommelabroller ORIGINAL



ORIGINAL

Hesse- Art.-Nr.	Modell Herstellernr.	Max. Trommelbreite (mm)	Max. Trommel (kg)	UVP in € zzgl. MwSt.
495000 GÄNGIG	Original A90101	520	200	255,00
495001	Original XL A90103	670	200	285,00
495004	Contour A90501	510	200	169,00



Zubehör CONTOUR
zu ORIGINAL

Clou



Clou Fix



Roll..Profi

Ringabwickler in Tasche Clou

Hesse- Art.-Nr.	Modell Herstellernr.	Tragfähigkeit (kg)	Gewicht (g)	UVP in € zzgl. MwSt.
495006	Clou A90220	80	7500	340,00
495009	Clou Fix 3er Set A90225 in Tasche	80	100	45,00

Roll..Profi

Kabelverlegung FLEXIPASS

Hesse- Art.-Nr.	Modell Herstellernr.	Max. Kabel Ø (mm)	Max. Klemmweite (mm)	UVP in € zzgl. MwSt.
495012	Flexipass A9022940	38	48	135,00
495014	Standfuß A90103	-	-	69,00
495013 GÄNGIG	Set (3 Stk.) in Tasche A90229	-	-	399,00
495027	L-Boxx (5 Stk.) A90298	-	-	625,00

FLEXIPASS L-BOXX



FLEXIPASS



FLEXIPASS Set



FLEXIPASS MULTI



FLEXIPASS MULTI
IN TASCHÉ

Roll..Profi

Kabelverlegung FLEXIPASS MULTI

Hesse- Art.-Nr.	Modell Herstellernr.	Verwendungs- bereich (mm)	Klemmweite (mm)	UVP in € zzgl. MwSt.
495034	Flexipass Multi (2 Stk. in Tasche) NEU A90240	46 - 220	69	449,00
495035	Flexipass Multi (2 Stk. in L-BOXX) NEU A90241	46 - 220	69	499,00

☆☆☆☆
SB Schuebo
Universalschlüssel



PATENTIERT
MADE IN GERMANY





Patentiert!

Schalterschrankschlüssel
472 M 03 / 1000-120



1000-120



Hesse- Art.-Nr.	Modell Herstellernr.	Schließungen	Maße (mm)	Gewicht (g)	UVP in € zzgl. MwSt.
400172	Schalterschrank- schlüssel 472 M 03	Innenvierkant: 5; 6; 7; 8 mm Innendreikant: 8; 9 mm Doppelbart: 3-5 mm 1/4" Sechskant Bitaufnahme	72 x 72	72	15,70
400177	Schalterschrank- schlüssel Doublehead Key	Innenvierkant: 5; 6; 7; 8 mm Innendreikant: 8; 9 mm Doppelbart: 3-5 mm 1/4" Sechskant Bitaufnahme	72 x 72	72	15,30

10 in 1

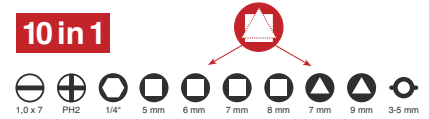

11 in 1

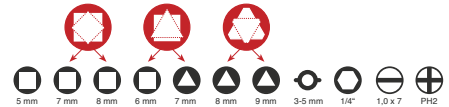

Schalterschrankschlüssel
Mini Key

Patentiert!



9 in 1



Hesse- Art.-Nr.	Modell Herstellernr.	Schließungen	Maße (mm)	Gewicht (g)	UVP in € zzgl. MwSt.
400187	Mini Key 520 M 03	Innenvierkant: 5; 6; 7-8 mm Innendreikant: 9 mm Doppelbart: 3-5 mm 1/4" Vierkant Bitaufnahme Doppelbit an Kette: PH2 / SL 1,0 x 7 mm	42 x 42	47	14,00



Schalterschrankschlüssel
SuB Key Elektro

10 in 1



Hesse- Art.-Nr.	Modell Herstellernr.	Schließungen	Maße (mm)	Gewicht (g)	UVP in € zzgl. MwSt.
400233	SuB Key Elektro 300-051	Innenvierkant: 5; 6; 7-8 mm Innendreikant: 9 mm Doppelbart: 3-5 mm Doppelbit: PH2 / SL 1,0 x 7 mm Kunststoffadapter für 1/4" Bits	140 x 25	102	19,20

Patentiert!



Patentiert!

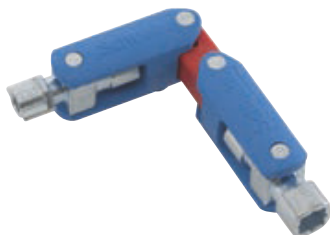

Schalterschrankschlüssel
Doublejoint Key

9 in 1

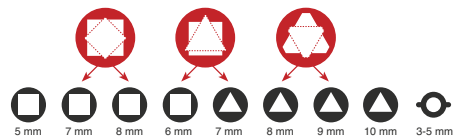

Hesse- Art.-Nr.	Modell Herstellernr.	Schließungen	Maße (mm)	Gewicht (g)	UVP in € zzgl. MwSt.
400190	Doublejoint Key 3000-160	Innenvierkant: 5; 6; 7; 8 mm Innendreikant: 7; 8; 9 mm Doppelbart: 3-5 mm	127 x 28	91	16,00



Schaltsschranckschlüssel
SubMaker Quadro Plus

14 in 1

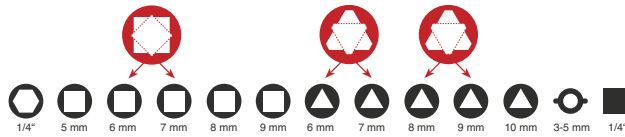

Patentiert!

Hesse- Art.-Nr.	Modell Herstellernr.	Schließungen	Maße (mm)	Gewicht (g)	UVP in € zzgl. MwSt.
400669	SubMaker Quadro Plus 4000-120	Innenvierkant: 5; 6-7; 8-9 mm Innendreikant: 6-7; 8-9; 10 mm Doppelbart: 3-5 mm 1/4" Vierkant Bitaufnahme 1/4" Sechskant Bitaufnahme	130 x 25	108	17,30



Patentiert!

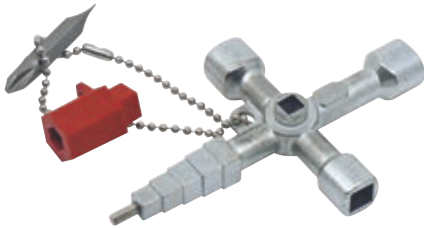

Schaltsschranckschlüssel
ProfiKey BAU

13 in 1



Hesse- Art.-Nr.	Modell Herstellernr.	Schließungen	Maße (mm)	UVP in € zzgl. MwSt.
400184 GÄNGIG	ProfiKey BAU 820-M03	Stufiger Vierkant 6 - 10 mm Innenvierkant: 5; 7; 8 mm Innendreikant: 9; 10 mm Madenschraube: 3 mm Doppelbit an Kette: PH2 / SL 1,0 x 7 mm 1/4" Sechskant Bitaufnahme	89 x 62 x 15	13,60

Schaltsschranckschlüssel
Master Key Elektro/Bau



Hesse- Art.-Nr.	Modell Herstellernr.	Schließungen	Maße (mm)	UVP in € zzgl. MwSt.
400677	Master Key Elektro 100-010	Innenvierkant: 5; 6; 7; 8 mm Innendreikant: 7; 9; 10 mm Doppelbart: 3-5 mm Doppelbit an Kette: PH2 / SL 1,0 x 7 mm 1/4" Sechskant Bitaufnahme	110 x 75	10,40
400670	Master Key Bau 100-150	Madenschraube: 3 mm Stufiger Vierkant 6 - 10 mm Innenvierkant: 5; 6; 7; 8 mm Innendreikant: 7; 9; 10 mm Doppelbit an Kette: PH2 / SL 1,0 x 7 mm 1/4" Sechskant Bitaufnahme	145 x 75	10,90



Master Key Elektro

Master Key Bau



PATENTIERT
MADE IN GERMANY

Schaltsschranckschlüssel
SuB Master

14 in 1



Hesse- Art.-Nr.	Modell Herstellernr.	Schließungen	Maße (mm)	UVP in € zzgl. MwSt.
400665 GÄNGIG	SuB Master 900-010	Innenvierkant: 5; 6; 7-8; 9-10 mm Innendreikant: 7; 8-9; 10-11 mm Buntbart: 3-5 mm Halbmond: 6 mm 1/4" Sechskant Bitaufnahme	95 x 95	29,00



Pfostenschlüssel

Dreikant-Spezienschlüssel nach DIN 3223

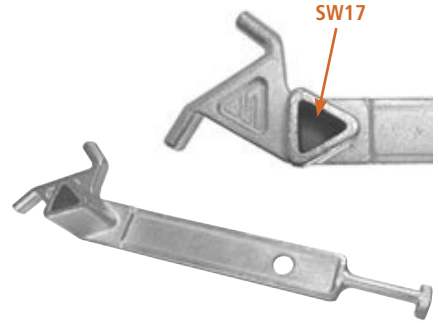

Hesse- Art.-Nr.	Modell Herstellernr.	Schließungen	Maße (mm)	Gewicht (g)	UVP in € zzgl. MwSt.
400218	Dreikant- Spezial- schlüssel 400218	SW17 Gesamtlänge 282 mm - entsprechend DIN 3223 Vordere Haken zum Öffnen von Sicherheitsverschlüssen an Pfosten, das T-Stück am Ende zur Entriegelung von Abdeckkappen.	130 x 25	108	18,80



Bauschlüssel PZ
42930



Hesse- Art.-Nr.	Modell Herstellernr.	Schließungen	UVP in € zzgl. MwSt.
400214 GÄNGIG	Bauschlüssel PZ 42930	Innenvierkant: 6; 7; 8 mm Stufiger Vierkant 7-10 mm Sechskant Schlüssel 3 mm Messkala bis 70 mm Mitnehmer für Schlösser	16,40



Perlator-
Universalschlüssel
1458097



Hesse- Art.-Nr.	Modell Herstellernr.	Schließungen	UVP in € zzgl. MwSt.
401010 GÄNGIG	Universal- schlüssel 1458097	M18x1, M22x1 Inneng., M24x1 Außeng., M28x1 Außeng. TT M16.5x1, TJM18.5x1, JR M21.5x1 und STD M24x1	12,50





Kunststoffklammer
625 / 627



1000 V

Hesse- Art.-Nr.	Modell Herstellernr.	Länge (mm)	Gewicht (g)	UVP in € zzgl. MwSt.
461139	Kunststoffklammer 625-160	160	70	9,40
491206	Kunststoffklammer 627-80	80	30	9,20



Isolierende Flachzange
623



1000 V

Hesse- Art.-Nr.	Modell Herstellernr.	Länge (mm)	Gewicht (g)	UVP in € zzgl. MwSt.
491234	Isol. Flachzange 623	200	106	23,30



Staubpinsel
710-1"



1000 V

Hesse- Art.-Nr.	Modell Herstellernr.	Pinselbreite	Länge (mm)	UVP in € zzgl. MwSt.
491296 ÖÄNGIG	Staubpinsel 710-1"	1" / 25 mm	400	8,80
491297	Staubpinsel 710-2"	2" / 50 mm	400	10,60



Selbstklemmtüllen
635



1000 V

Hesse- Art.-Nr.	Modell Herstellernr.	Isolation	Maße \varnothing x L (mm)	UVP in € zzgl. MwSt.
460947	SELBSTKLEMM- TÜLLEN 635-10x40	bis 1.000 V	10 x 40 mm	3,20
460946	SELBSTKLEMM- TÜLLEN 635-10x75	bis 1.000 V	10 x 75 mm	3,20
491240	SELBSTKLEMM- TÜLLEN 635-20x100	bis 1.000 V	100 x 20 mm	3,50
460948	SELBSTKLEMM- TÜLLEN 635-30x120	bis 1.000 V	120 x 30 mm	4,10
460949	SELBSTKLEMM- TÜLLEN 635-40x135	bis 1.000 V	135 x 40 mm	5,80



Schonhammer
745-25





1000 V

Hesse- Art.-Nr.	Modell Herstellernr.	Kopf \varnothing (mm)	Gewicht (g)	UVP in € zzgl. MwSt.
491221	Schonhammer 745-25	25	600	78,40
491199 ÖÄNGIG	Schonhammer 745-35	35	830	84,80

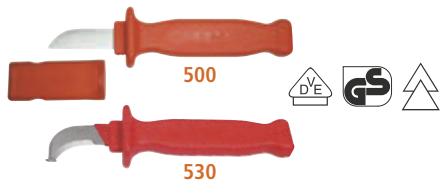

Messer VDE
500 / 530



Hesse-Art.-Nr.	Modell Herstellernr.	Länge d. Klinge (mm)	Gewicht (g)	UVP in € zzgl. MwSt.
460880	Messer VDE No. 500	50	105	10,20
460885	Messer VDE No. 530	40	100	22,00



Umschaltknarre/
Steckschlüssel-Einsatz
300 / 350



Hesse-Art.-Nr.	Modell Herstellernr.	Antrieb	Maße (mm)	Gewicht (g)	UVP in € zzgl. MwSt.
461220	Umschaltknarre No. 300	3/8"	190	370	106,80
491251	Steckschlüssel 320-13	3/8"	12 od. 13	70	22,70
461242	Steckschlüssel 350 05x65	3/8"	65	50	18,60
461244	Steckschlüssel 350 06x65	3/8"	65	50	18,60



Spreizkeil
742



Hesse-Art.-Nr.	Modell Herstellernr.	Maße (mm)	Gewicht (g)	UVP in € zzgl. MwSt.
461266	Spreizkeil No. 742	225 x 45 x 30	225	26,70



Abdecktuch
EPDM-Schutzmatte



Hesse-Art.-Nr.	Modell Herstellernr.	Maße (mm)	Gewicht (g)	UVP in € zzgl. MwSt.
491200	EPDM-Schutzmatte 491200	1000 x 1000	1800	70,80



Quergriff-Schraubendr. VDE
360



Hesse-Art.-Nr.	Modell Herstellernr.	Maße (mm)	Gewicht (g)	UVP in € zzgl. MwSt.
461063	T-Griff VDE 360 05x200	5 x 200	120	16,90
461067	T-Griff VDE 360 06x250	6 x 250	320	17,50



3/8" - 12 / 13 mm (491251)



3/8" - 5x65 mm (461242)



3/8" - 6x65 mm (461244)

NH-Aufsteckgriff
680



Hesse-Art.-Nr.	Modell Herstellernr.	Länge (mm)	Gewicht (g)	UVP in € zzgl. MwSt.
460940	NH-Aufsteckgriff 680	445	470	65,20



Paßschraubenschlüssel
E216112



Hesse-Art.-Nr.	Modell Herstellernr.	Maße (mm)	Gewicht (g)	UVP in € zzgl. MwSt.
480799	Schraubenschl. E216112	105 x 30 x 30	50	11,60

Das Nonplus Xtra!

Die PowerTOP® Xtra Familie von 16 bis 125 A.





MENNEKES

MENNEKES

CEE Stecker

PowerTOP® Xtra / PowerTOP® Xtra S

- ▶ Schraubanschlusstechnik ErgoCONTACT® / Schraubenlose Schneid-Klemm-Technik SafeCONTACT
- ▶ Ergonomische Gehäuseform mit genoppten Griffflächen
- ▶ Gummierte Verschraubung mit Abdichtung
- ▶ Zugentlastung und Kabelknickschutz



Hesse-Art.-Nr.	Modell Herstellernr.	Stromstärke (A)	Spannung (V)	Farbe	UVP in € zzgl. MwSt.
485860	PowerTOP® Xtra 13502	16 A (3p)	230	Blue	9,40
485852	PowerTOP® Xtra 13510	16 A (5p)	400	Red	8,00
485853	PowerTOP® Xtra 13520	32 A (5p)	400	Red	11,00
485861	PowerTOP® Xtra 13521	16 A (3p)	230	Blue	10,70
485856	PowerTOP® Xtra 13522	16 A (5p)	400	Red	9,20
485857	PowerTOP® Xtra 13523	32 A (5p)	400	Red	12,80

ErgoCONTACT®

SafeCONTACT **NEU**



13502

Bild © MENNEKES



13510 | 13520



13521

Bild © MENNEKES



13522 | 13523

MENNEKES

CEE Stecker

PowerTOP® Xtra R

- ▶ Schraubkontakt | ▶ Gummierte Griffflächen
- ▶ Verschraubung mit Abdichtung | ▶ Rahmenklemmen
- ▶ Hochwärmebeständige Kontaktträger
- ▶ Vernickelte Kontakte
- ▶ IP67 = Wasserdichte Stecker mit Schraubanschlusstechnik



Hesse-Art.-Nr.	Modell Herstellernr.	Stromstärke (A)	Spannung (V)	Farbe	UVP in € zzgl. MwSt.
485915	PowerTOP® Xtra R 13112	63 A (5p)	400	Red	79,50
485916*	PowerTOP® Xtra R 13212	63 A (5p)	400	Red	104,40
485919*	PowerTOP® Xtra R 13225	125 A (5p)	400	Red	404,10

IP54

IP67

IP67



13112

Bild © MENNEKES



13212 / 13225

*IP67 = Wasserdichte Stecker mit Schraubanschlusstechnik



Bild ©: MENNEKES

- ▶ Schraubanschlusstechnik ErgoCONTACT® / Schraubenlose Schneid-Klemm-Technik SafeCONTACT
- ▶ Ergonomische Gehäuseform mit genoppten Griffflächen
- ▶ X-CONTACT®
- ▶ Gummierete Verschraubung mit Abdichtung
- ▶ Zugentlastung und Kabelknickschutz

Hesse- Art.-Nr.	Modell Herstellernr.	Stromstärke (A)	Spannung (V)	Farbe	UVP in € zzgl. MwSt.
485862	PowerTOP® Xtra 14502	16 A (3p)	230	●	11,50
485854	PowerTOP® Xtra 14510	16 A (5p)	400	●	9,20
485855	PowerTOP® Xtra 14520	32 A (5p)	400	●	13,30
485863	PowerTOP® Xtra 14521	16 A (3p)	230	●	12,80
485858	PowerTOP® Xtra 14522	16 A (5p)	400	●	12,00
485859	PowerTOP® Xtra 14523	32 A (5p)	400	●	15,30

ErgoCONTACT®



14502

Bilder ©: MENNEKES



14510 / 14520

SafeCONTACT®



14521

Bilder ©: MENNEKES



14522 / 14523

MENNEKES

CEE Kupplung

PowerTOP® Xtra

- ▶ Schraubkontakt
- ▶ Gummierete Griffflächen
- ▶ Rahmenklemmen
- ▶ X-CONTACT®
- ▶ Hochwärmeebeständige Kontaktträger
- ▶ Verschraubung mit Abdichtung
- ▶ Zugentlastung und Kabelknickschutz
- ▶ IP67=Wasserdichte Kupplung

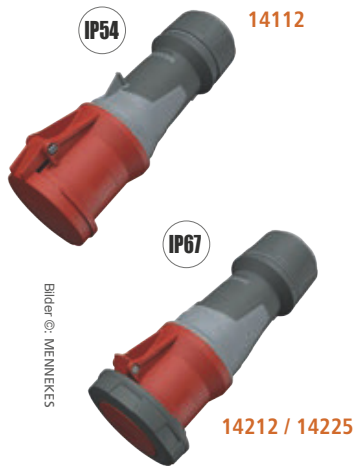

Bilder ©: MENNEKES



Hesse- Art.-Nr.	Modell Herstellernr.	Stromstärke (A)	Spannung (V)	Farbe	UVP in € zzgl. MwSt.
485917	PowerTOP® Xtra 14112	63 A (5p)	400	●	94,80
485918	PowerTOP® Xtra 14212	63 A (5p)	400	●	166,70
485920	PowerTOP® Xtra 14225	125 A (5p)	400	●	459,80

IP54

IP67

IP67

- ▶ IP67 = Wasserdichte Kupplung

Sortimente

PowerTOP® Xtra



Stecker PowerTOP® Xtra:

- ▶ Schraubanschlusstechnik ErgoCONTACT®
- ▶ Ergonomische Gehäuseform mit genoppten Griffflächen
- ▶ Gummierte Verschraubung mit Abdichtung
- ▶ Zugentlastung und Kabelknickschutz



Kupplung PowerTOP® Xtra:

- ▶ Schraubanschlusstechnik ErgoCONTACT®
- ▶ Ergonomische Gehäuseform mit genoppten Griffflächen
- ▶ X-CONTACT®
- ▶ Gummierte Verschraubung mit Abdichtung
- ▶ Zugentlastung und Kabelknickschutz



Bild © MENNEKES

Hesse- Art.-Nr.	Bestückung	Farbe	UVP in € zzgl. MwSt.
485908	2-teilig: 1x CEE Stecker PowerTOP® Xtra 16A 5p 6h 400V IP54 (13510) 1x CEE Kupplung PowerTOP® Xtra 16A 5p 6h 400V IP54 (14510)	●	16,80
485909	2-teilig: 1x CEE Stecker PowerTOP® Xtra 32A 5p 6h 400V IP54 (13520) 1x CEE Kupplung PowerTOP® Xtra 32A 5p 6h 400V IP54 (14520)	●	23,80
485910	2-teilig: 1 x CEE Stecker PowerTOP® Xtra 16A 3p 6h 230V IP54 (13502) 1 x CEE Kupplung PowerTOP® Xtra 16A 3p 6h 230V IP54 (14502)	●	17,50



485908



485909



485910

ProTOP®

- ▶ Schraubkontakt
- ▶ Verschraubung mit Abdichtung
- ▶ Zugentlastung und Kabelknickschutz
- ▶ Gehäuse mit Gewindeverschluss und Sicherungsschieber

Hesse- Art.-Nr.	Modell Herstellernr.	Stromstärke (A)	Spannung (V)	Farbe	UVP in € zzgl. MwSt.
485867	ProTOP® 3319A	16 A (5p)	400	●	33,50
485868	ProTOP® 3322	32 A (5p)	400	●	40,10



Bild © MENNEKES

3319A / 3322



1341

Bilder © MENNEKES



31 / 32

Wandsteckdose

TwinCONTACT

- ▶ Schraubenlose Feder-Klemm-Technik
- ▶ Befestigung von außen

Hesse- Art.-Nr.	Modell Herstellernr.	Stromstärke (A)	Spannung (V)	Farbe	UVP in € zzgl. MwSt.
485866	TWINCONTACT 1341	16 A (3p)	230	●	20,80
485864	TWINCONTACT 31	16 A (5p)	400	●	9,00
485865	TWINCONTACT 32	32 A (5p)	400	●	13,80

Die Steckvorrichtungen sind unter anspruchsvollsten Bedingungen sicher und haben eine extra lange Lebensdauer. Die CEE Stecker mit genoppten Griffzonen und Kupplungen liegen auch bei Feuchtigkeit und Nässe rutschfest in der Hand.



Ohne Kupplung

485886
5x 2,5 mm²

485890
5x 4,0 mm²

485896
5x 16,0 mm²

485901
5x 2,5 mm²

485911
5x 2,5 mm²

Hesse- Art.-Nr.	Modell Herstellernr.	Länge (m)	Gummikabel (ø mm ²)	Stromstärke (A)	Spannung (V)	Farbe	Gewicht (kg)	UVP in € zzgl. MwSt.
485879	PowerTOP® Xtra 0001-HE	5	5G x 1,5	16	400	●	-	58,50
485880	PowerTOP® Xtra 0002-HE	10	5G x 1,5	16	400	●	-	80,00
485881	PowerTOP® Xtra 0003-HE	25	5G x 1,5	16	400	●	-	144,40
485885	PowerTOP® Xtra 0004-HE	5	5G x 2,5	16	400	●	2,65	54,90
485886	PowerTOP® Xtra 0005-HE	10	5G x 2,5	16	400	●	4,26	80,70
485887	PowerTOP® Xtra 0006-HE	25	5G x 2,5	16	400	●	-	185,40
485888	PowerTOP® Xtra 0007-HE	50	5G x 2,5	16	400	●	-	331,00
485889	PowerTOP® Xtra 0008-HE	5	5G x 4	32	400	●	-	100,50
485890	PowerTOP® Xtra 0009-HE	10	5G x 4	32	400	●	5,29	119,50
485891	PowerTOP® Xtra 0010-HE	25	5G x 4	32	400	●	-	277,40
485895	PowerTOP® Xtra 0011-HE	50	5G x 4	32	400	●	-	507,70
485896	PowerTOP® Xtra 0012-HE	10	5G x 16	63	400	●	17,25	507,70
485897	PowerTOP® Xtra 0013-HE	25	5G x 16	63	400	●	36,72	960,00
485911	PowerTOP® Xtra 0040-HE_M	5	5G x 2,5	16	400	●	-	49,60
485901	PowerTOP® Xtra 0016-HE	10	5G x 2,5	16	400	●	3,120	94,70
485902	PowerTOP® Xtra 0017-HE	25	5G x 2,5	16	400	●	-	216,70
485898	PowerTOP® Xtra 0014-HE	10	5G x 6	32	400	●	-	217,90
485899	PowerTOP® Xtra 0015-HE	25	5G x 6	32	400	●	-	447,70
485904	PowerTOP® Xtra Adapter 0020-HE	0,5	5G x 2,5	16/32	400	●	-	47,70

Stückgeprüft
nach
DGUV-V3

Speditions-
versand

Speditions-
versand

Speditions-
versand

Maschinenanschlussleitung

MENNEKES

Stecker SCHUKO®



Bild ©: MENNEKES

Hesse- Art.-Nr.	Modell Herstellernr.	Stromstärke (A)	Spannung (V)	UVP in € zzgl. MwSt.
485869	SCHUKO® 152042	16 A (2p+E)	230	12,10

- ▶ Schraubklemmen
- ▶ Mit Kabelverschraubung
- ▶ Mit selbstschließendem Klappdeckel
- ▶ Großer Anschlussraum für Leitungen bis 3x2,5 mm², bis H07RN-F

MENNEKES

Kupplung SCHUKO®



Bild ©: MENNEKES

Hesse- Art.-Nr.	Modell Herstellernr.	Stromstärke (A)	Spannung (V)	UVP in € zzgl. MwSt.
485870	SCHUKO® 158041	16 A (2p+E)	230	19,00

- ▶ Schraubklemmen
- ▶ Mit Kabelverschraubung
- ▶ Mit selbstschließendem Klappdeckel
- ▶ Großer Anschlussraum für Leitungen bis 3x2,5 mm², bis H07RN-F

MENNEKES

Verlängerungskabel SCHUKO®



IP44

- ▶ Polyurethan-Außenmantel
- ▶ Für Leitungen bis 3 x 2,5 mm², bis H07BQ-F
- ▶ Mit Kabelbindern gebunden

Hesse- Art.-Nr.	Modell Herstellernr.	Länge (m)	Gummikabel (ø mm ²)	Stromstärke (A)	Spannung (V)	Farbe	UVP in € zzgl. MwSt.
485914	SCHUKO® 0029-HE	5	3G x 2,5	16A (2p+E)	230	●	38,50
485912	SCHUKO® 0030-HE	10	3G x 2,5	16A (2p+E)	230	●	56,80
485913	SCHUKO® 0031-HE	25	3G x 2,5	16A (2p+E)	230	●	107,50



Stückgeprüft
nach
DGUV-V3



MENNEKES

Steckdosenleiste EverGUM®



Bild ©: MENNEKES

Hesse- Art.-Nr.	Modell Herstellernr.	Bestückung	UVP in € zzgl. MwSt.
485877	EverGUM® 70026	6x SCHUKO® 16 A, 2p+E, 230 V	480,50
485878	EverGUM® 70028	1x CEE 16 A, 5 p, 400 V 4x SCHUKO® 16 A, 230 V	569,80

- ▶ Anschluss / Zuleitung:
70026: 2 m H07RN-F3G1,5 mit Stecker SCHUKO® 16 A, 230 V
70028: 2 m H07RN-F5G2,5 mit CEE-Stecker 16 A, 5 p, 400 V

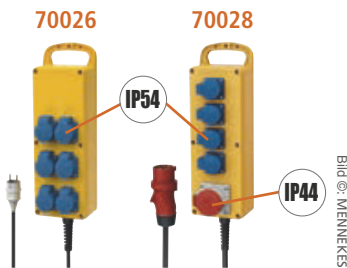

MENNEKES

Steckdosenkombination EverGUM®



Bild ©: MENNEKES

Hesse- Art.-Nr.	Modell Herstellernr.	Bestückung	UVP in € zzgl. MwSt.
485873	EverGUM® 70351	1x CEE 32 A, 5 p, 400 V 1x CEE 16 A, 5 p, 400 V 4x SCHUKO® 16 A, 230 V	842,60
485872	EverGUM® 70352	2x CEE 16 A, 5 p, 400 V 4x SCHUKO® 16 A, 230 V	800,00
485871	EverGUM® 70724	8x SCHUKO® 16 A, 230 V	984,70

- ▶ Anschluss / Zuleitung:
70351: 2 m H07RN-F5G4 mit CEE-Stecker 32 A, 5 p, 400 V
70352: 2 m H07RN-F5G2,5 mit CEE-Stecker 16 A, 5 p, 400 V
70724: 2 m H07RN-F5G2,5 mit CEE-Stecker 16 A, 5 p, 400 V

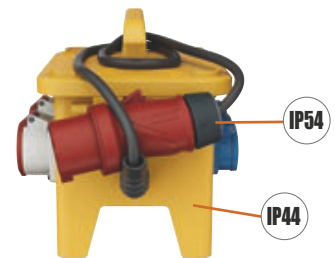

Für mehr Infos:





Werkzeugkoffer, leer
ATOMIK WH PTS



Hesse- Art.-Nr.	Modell Herstellernr.	Ausführung	Innenmaße (mm)	Gewicht (kg)	UVP in € zzgl. MwSt.
488061 GÄNGIG	ATOMIK WH PTS 488061	<ul style="list-style-type: none"> • 24 Einsteckfächern auf der 2-seitigen Werkzeugtafel • 12 Gummilaschen und 1 gr. Tasche auf der 2-seitigen Werkzeugtafel • 6 Einsteckfächer und 9 Gummilaschen auf der Abdeckplatte • 1x frei unterteilbare Bodenschale, Höhe 160 mm mit Abdeckplatte • 1x Klemmfach f. Dokumente im Deckel • 2x abschließbare Schlösser + Schlüssel 	465 x 354 x 245	6.4 (leer)	285,30



*Werkzeuge sind nicht im Lieferumfang enthalten

Werkzeugkoffer, leer
NEW MEGA WHEELS PTS



Hesse- Art.-Nr.	Modell Herstellernr.	Ausführung	Innenmaße (mm)	Gewicht (kg)	UVP in € zzgl. MwSt.
488150	New Mega Wheels PTS 488150	<ul style="list-style-type: none"> • 2 Werkzeugtafeln mit Einstecktaschen, eine Tafel einseitig, andere beidseitig bestückbar • 1x Dokumentenfach • 2x Kleinteileboxen (Art. WL01/ WL02) • 2 abschließbare TSA Schlössern + Schlüssel • Bodenraum mit verstellbaren Einteilungen • Einrastender Teleskopgriff • Große leichtgängige Transportrollen 	473 x 369 x 1705	8.0 (leer)	366,10



*Werkzeuge sind nicht im Lieferumfang enthalten

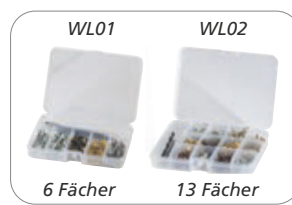



Werkzeugkoffer, leer
V-ROCK TURTLE PTS



Hesse-Art.-Nr.	Modell Herstellernr.	Ausführung	Innenmaße (mm)	Gewicht (kg)	UVP in € zzgl. MwSt.
488153	V-ROCK TURTLE PTS 488153	<ul style="list-style-type: none"> • Neues Öffnungssystem mit stabilen Gasdruckfedern, was schonendes Auf- und Zuklappen des Koffers ermöglicht • NEU: Größere Transportrollen Ø 120 mm mit abgedichteten Kugellagern • Runde Kunststoffverstärkung für die Ecken • 2 abschließbare TSA Schlössern • Deckeltafel: zweiseitig bestückbar; 24 Einsteckfächer; 12 Schlaufen; 1 Tasche mit Klettverschluss • Bodentafel: einseitig bestückbar; 6 Einsteckfächer; 12 Schlaufen • Dokumentenfach im Deckel • 3x Kleinteileboxen (Art. WL01/ WL02) • Innenliegende Kunststoffwanne mit vorgeschnittem Schaumeinsatz • Stabiler, gummierter und verstärkter Teleskopgriff 	470 x 385 x 330	9.0 (leer)	433,20



Bodenschale mit Schaumeinsatz

Mit TSA-Schlösser

*Werkzeuge sind nicht im Lieferumfang enthalten



Werkzeugkoffer, leer
ROCK TURTLE PTS



Hesse-Art.-Nr.	Modell Herstellernr.	Ausführung	Innenmaße (mm)	Gewicht (kg)	UVP in € zzgl. MwSt.
488084 GÄNGIG	ROCK TURTLE PTS 488084	<ul style="list-style-type: none"> • Dokumentenfach im Deckel • 2 abschließbare TSA-Schlösser • 1 ergonomischer Zweikomponenten-Griff • Einrastender Teleskopgriff und große leichtgängige Transportrollen • Großer Stauraum für Hand- und Elektrowerkzeuge im Bodenbereich • Zuverlässiges und in mehreren Punkten vernietetes Scharnier • 2 Deckelhalterungen mit Arretierungssystem • 2 Kleinteilebehälter (Art. WL01/ WL02) 	470 x 390 x 300	9.0 (leer)	433,20



Bodenschale mit Schaumeinsatz

*Werkzeuge sind nicht im Lieferumfang enthalten



Großer Stauraum



TSA-Schloss





Werkzeugkoffer, leer
All.In.One



- 2 seitliche Handgriffe
- Einrastender Teleskopgriff bis 99 cm ausziehbar
- 4 selbstschmierende Rollen
- 4 Frontklappen-Verschlüsse
- Integrierte Sperrvorrichtung f. Schubladen
- Herausnehmbare Ablage mit 2 Griffen und Beschriftungsfeld
- Deckel und Frontklappe abnehmbar
- Zentral ü. Zylinderschloss verschließbar
- Jede Klappe separat über Vorhängeschloss verschließbar
- Im Lieferumfang sind 5 Kleinteileboxen (2x WL01 (488908), 2x WL02 (488909), 1x WL04 (488912)) enthalten

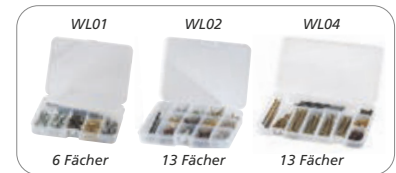

Hesse- Art.-Nr.	Modell Herstellernr.	Ausführung	Innenmaße (mm)	Gewicht (kg)	UVP in € zzgl. MwSt.
488075 GÄNGIG	All.In.One KT01	4 Schubladen, Schaumeinlage und Boxen	581 x 381 x 455	14.1 (leer)	443,20
488077	All.In.One KT02	4 Schubladen, ohne Schaumeinlagen u. Boxen	381 x 581 x 455	13.35 (leer)	390,50



ALL.IN.ONE AI1.KT01



*Werkzeuge sind nicht im Lieferumfang enthalten



Werkzeugkoffer, leer
BOXER WH PTS



Hesse- Art.-Nr.	Modell Herstellernr.	Ausführung	Innenmaße (mm)	Gewicht (kg)	UVP in € zzgl. MwSt.
488034	BOXER WH PTS 488034	<ul style="list-style-type: none"> • Deckeltafel (mit Arretierungssystem) zweiseitig bestückbar: 1 Dokumentenfach und 6 Einstecktaschen, 12 Einstecktaschen und 8 Gummibandhalterungen • Bodentafel einseitig bestückbar: 6 Einstecktaschen und 8 Gummibandhalterungen • 2 seitliche Klappverschlüsse mit Schloss • 1 Deckelhalter mit Arretierungssystem • Ergonomischer, 2-Komp.-Tragegriff • Teleskopgriff m. Kugelgelagerten Rollen • Inkl. 2 Kleinteileboxen • 3 Trennstegen 	430 x 340 x 190	5.0 (leer)	191,30



Werkzeug-Umhängetasche, leer
PSS COMPACT BAG



*Werkzeuge sind nicht im Lieferumfang enthalten



Hesse- Art.-Nr.	Modell Herstellernr.	Ausführung	Außmaß (mm)	Gewicht (kg)	UVP in € zzgl. MwSt.
488052 GÄNGIG	PSS COMPACT BAG 488052	Wasserdichter Kunststoffboden, 2 Außentaschen, je 1x WL01 / 1x WL02 Kunststoffboxen, 2 herausnehmbare Werkzeugaufnahmen PSS™ mit drei Einsteckschienen, gepolsterter Tragegriff	330 x 110 x 330	1.5 (leer)	73,60





Werkzeugsack, leer

SOFT TROLLEY 01 R / TOOL TROLLEY 01 R

2 gepolsterte verstellbare Schultergurte, herausziehbarer Teleskopgriff, stabiler Tragegriff, mit Schaum gepolstertes Laptopfach im Inneren (bis 15"), herausnehmbare, zweiseitig bestückbare Werkzeugtafel mit Einstecktaschen und eine zusätzliche Tasche für die Aufnahme von Werkzeugen (Fronttasche).

Hesse- Art.-Nr.	Modell Herstellernr.	Außenmaße (mm)	Gewicht (kg)	UVP in € zzgl. MwSt.
488160	SOFT TROLLEY 01 R 488160	310 x 190 x 480	2.5 (leer)	131,80
488126	TOOL TROLLEY 01 R 488126	360 x 200 x 480	4.3 (leer)	169,90



SOFT TROLLEY 01 R

*Werkzeuge sind nicht im Lieferumfang enthalten



TOOL TROLLEY 01 R



MONOLITH LT35



Werkzeugsack, leer

MONOLITH



MONOLITH LT20



Hesse- Art.-Nr.	Modell Herstellernr.	Ausführung	Außenmaße (mm)	Gewicht (kg)	UVP in € zzgl. MwSt.
490006 NEU	Monolith LT20 WL00222	Gepolsterter Rückenteil, verstellbare Schultergurte, stabiler Tragegriff, kompakter Kunststoffrahmen verhindert ein Umkippen des Rucksacks, mit 26 Innentaschen, 6 Gummibändern und Fächern für Zubehör ermöglicht er den organisierten Transport von bis zu 44 Werkzeugen. Hauptmaterial: EVA / Materialstärke: 600 Denier-Fasern	370 x 240 x 480	2.34 (leer)	140,00
489082 NEU	Monolith LT35 WL00097	Gepolsterter Rückenteil, verstellbare Schultergurte, stabiler Tragegriff, kompakter Kunststoffrahmen verhindert ein Umkippen des Rucksacks, Vordertasche, großes Innenfach mit 43 Einstecktaschen sowie eine herausnehmbare Werkzeugtafel. Hauptmaterial: EVA / Materialstärke: 600 Denier-Fasern	430 x 270 x 570	3.8 (leer)	200,00
489959 NEU	Monolith Cross LT 40 WL00221	Mit Rollen. Gepolsterter Rückenteil, verstellbare Schultergurte, stabiler Tragegriff, kompakter Kunststoffrahmen verhindert ein Umkippen des Rucksacks. Mit 46 Taschen, 6 elastischen Schlaufen und einem doppelt herausnehmbaren Werkzeugpaneel bietet er eine überlegene Lade- und Organisationskapazität für bis zu 66 Werkzeuge. Hauptmaterial: EVA / Materialstärke: 600 Denier-Fasern	370 x 300 x 560	6,22 (leer)	330,00



MONOLITH CROSS LT 40



Leichte Transportbox aus extrem widerstands-fähigem Polypropylen (PP) mit viel Stauraum. Ideal für den Außeneinsatz, Wartungsarbeiten, Transport, Schifffahrt uvm. Verstärkter Deckel mit 3 Scharnieren und 2 Kippverschlüssen mit der zusätzlichen Möglichkeit ein Vorhängeschloss anzubringen. Zusätzliche Tragegriffe an beiden Kofferenden ermöglichen das komfortable Tragen mit 2 Personen.

Bei MUB 78: Die Rollen zusammen mit einem robusten Teleskopgriff am Koffer erleichtern den Transport zusätzlich.

Ausführung:

- Wasserabweisend • Kälte-/Hitzebeständig • Schlagfest • Stapelbar • Namenschild

MUB 78

Hesse-Art.Nr.	Herstellernr.	Ausführung	Innenmaße AxBxC (mm)	Gewicht (kg)	UVP in € zzgl. MwSt.
488283	MUB 65	leer	653 x 340 x 312	4.5	74,10
488235	MUB 78	leer	780 x 410 x 330	6.3	120,70





PLANO®



Kunststoffkoffer

911 Design line

Praktischer Kunststoffkoffer mit zwei herausnehmbaren Organismen Mod. 3452 im Deckel. Geräumiges unteres Fach zur Werkzeugaufbewahrung mit Inneneinsatz. Schlagfest mit ergonomischem Tragegriff.

Hesse-Art.-Nr.	Modell Herstellernr.	Maße (mm)	Gewicht (kg)	UVP in € zzgl. MwSt.
488302	Kunststoffkoffer 911 Design line	440 x 260 x 260	2.0 (leer)	35,50
488304	Kunststoffkoffer 959 Design line	390 x 360 x 150	2.0 (leer)	29,60



911



959



Kunststoffkoffer

451 / 651 / 702

Der Kunststoffkoffer Plano 451 mit rutschfestem Gummigriff hat ein geräumiges Fach zur Werkzeugaufbewahrung sowie ein herausnehmbares Kleinteilefach. Der Verschluss ist aus Metall. Vorhängeschlossmöglichkeit vorhanden.



451

702

Hesse-Art.-Nr.	Modell Herstellernr.	Maße (mm)	Gewicht (kg)	UVP in € zzgl. MwSt.
488314	Kunststoffkoffer 451	420 x 230 x 230	1.4 (leer)	23,50
488308	Kunststoffkoffer 651	510 x 280 x 290	2.3 (leer)	31,30
488311	Kunststoffkoffer 702	560 x 340 x 340	3.1 (leer)	55,00

GÄNGIG



Kunststoffkoffer

652

Praktischer Kunststoffkoffer mit zwei herausnehmbaren Organismen Mod. 3452 im Deckel. Geräumiges unteres Fach zur Werkzeugaufbewahrung mit Inneneinsatz. Schlagfest mit ergonomischem Tragegriff.

Hesse-Art.-Nr.	Modell Herstellernr.	Maße (mm)	Gewicht (kg)	UVP in € zzgl. MwSt.
488307	Kunststoffkoffer 652	510 x 280 x 290	2.3 (leer)	35,00





Kleinteileboxen

3449 - 3750Pro

Transparente Kunststoffboxen aus Polypropylen für Kleinteile.
(Der abgebildete Inhalt ist nicht im Lieferumfang enthalten.)

Hesse- Art.-Nr.	Modell Herstellernr.	Maße (mm)	Gewicht (kg)	UVP in € zzgl. MwSt.
488330	Kleinteilebox 3449	165 x 120 x 35	90	3,90
488328	Kleinteilebox 3600Pro	275 x 180 x 40	350	9,00
488329	Kleinteilebox 3700Pro	355 x 230 x 50	520	14,80
488399	Kleinteilebox 3750Pro	355 x 220 x 50	400	14,80



3449



3600Pro



3700Pro



3750Pro



Werkzeuggürteltasche

522TB



Die Universal-Gürteltasche hat eine Schlaufe sowie einen zusätzlichen Gürtelclip. Die Tasche wird über einen Klettverschluss sicher verschlossen und hat im Inneren drei Taschen, zwei kleine und eine große Tasche.

Hesse- Art.-Nr.	Modell Herstellernr.	Maße (mm)	Gewicht (g)	UVP in € zzgl. MwSt.
488367 GÄNGIG	Gürteltasche 522TB	170 x 100 x 50	86	12,00



Werkzeuggürteltasche

524TB



Diese Gürteltasche ist ideal zur Aufnahme von Scheren und Zangen. Die Tasche hat eine offene Tasche, die gut ausgeformt ist und so schnell und leicht die Werkzeuge aufnimmt.

Hesse- Art.-Nr.	Modell Herstellernr.	Maße (mm)	Gewicht (g)	UVP in € zzgl. MwSt.
488342	Gürteltasche 524TB	220 x 110 x 20	72	10,20



Werkzeuggürteltasche

526TB



Hammerhalter aus verstärktem Polyester. Verstärkt auf der Rückseite. Metallhaken für jeden Hammertyp. Bequeme Polsterung.

Hesse- Art.-Nr.	Modell Herstellernr.	Maße (mm)	Gewicht (g)	UVP in € zzgl. MwSt.
488388	Gürteltasche 526TB	170 x 100 x 50	150	15,30



Werkzeuggürtel

530TB



Der Gürtel wird aus doppelt gefasstem, schwarzen Korduramaterial gefertigt. Dieser hat eine Materialbreite von 6,5 cm und passt in jede handelsübliche Arbeitshose.

Hesse- Art.-Nr.	Modell Herstellernr.	Einstellbare Länge (cm)	Gewicht (g)	UVP in € zzgl. MwSt.
488344 GÄNGIG	Werkzeuggürtel 530TB	90 - 150	150	7,70



Werkzeuggürteltasche

531TB



Hesse- Art.-Nr.	Modell Herstellernr.	Maße (mm)	Gewicht (g)	UVP in € zzgl. MwSt.
488345	Gürteltasche 526TB	170 x 100 x 50	150	11,50



Werkzeuggürteltasche

533TB



Hesse- Art.-Nr.	Modell Herstellernr.	Maße (mm)	Gewicht (g)	UVP in € zzgl. MwSt.
488346	Gürteltasche 533TB	290 x 250 x 30	269	14,60



Werkzeuggürteltasche
534TB



Werkzeuggürteltasche für Kleinteile und Werkzeuge, gefüttert. Mit Innen- und Außentaschen inkl. Schnapping. Mehrere unterschiedlich große Fächer.

Hesse- Art.-Nr.	Modell Herstellernr.	Maße (mm)	Gewicht (g)	UVP in € zzgl. MwSt.
488347	Gürteltasche 534TB	290 x 250 x 30	263	14,60



Messertasche
536TB



Messertasche mit Klingen- und Kugelschreiberhalter. Metallclip für jeden Gürteltyp geeignet.

Hesse- Art.-Nr.	Modell Herstellernr.	Maße (mm)	Gewicht (g)	UVP in € zzgl. MwSt.
488402 GÄNGIG	Messertasche 536TB	250 x 85 x 30	59	11,50



Werkzeuggürtel
537TB



Kleinteile- oder Nageltasche aus doppelt verstärktem Polyester mit integrierter Gürtelschleife 6,5 cm. Nach oben offenes Kleinteile-Fach.

Hesse- Art.-Nr.	Modell Herstellernr.	Maße (mm)	Gewicht (g)	UVP in € zzgl. MwSt.
488365 GÄNGIG	Gürteltasche 537TB	200 x 260 x 50	152	8,70



Umhängetasche
556TB



Die kleine Werkzeug - Umhängetasche hat einen abnehmbaren Umhängegurt, eine Gürtelschleife 9 cm und eine Trageschleife.

Hesse- Art.-Nr.	Modell Herstellernr.	Maße (mm)	Gewicht (g)	UVP in € zzgl. MwSt.
488370 GÄNGIG	Umhängetasche 556TB	210 x 130 x 30	132	18,70



Handygürteltasche
539XL



Werkzeuggürteltasche speziell für Smartphones mit gepolsterter Innentasche. Für Smartphones bis zu 6,5 Zoll.

Hesse- Art.-Nr.	Modell Herstellernr.	Maße (mm)	Gewicht (g)	UVP in € zzgl. MwSt.
488371	Handygürtel- tasche 539XL	165 x 100 x 50	96	15,10



Werkzeuggürtel
52180TB



Besteht aus vier Teilen. Der gepolsterte Gürtel ist von 90 bis 120 cm einstellbar. Eine Tasche ist für den Akkuschrauber, eine für Kleinteile, die größte Tasche ist für Werkzeuge und Hämmer vorgesehen.

Hesse- Art.-Nr.	Modell Herstellernr.	Ausführung	Gewicht (g)	UVP in € zzgl. MwSt.
488312	Werkzeuggürtel 52180TB	4 Gürtel- taschen	550	36,50



Werkzeuggürteltasche
544/545TB

Kleinteile- oder Nageltasche aus doppelt verstärktem Polyester mit integrierter Gürtelschleife 6,5 cm, einstellbar von 90 - 140 cm.

Hesse- Art.-Nr.	Modell Herstellernr.	Ausführung	Maße (mm)	Gewicht (g)	UVP in € zzgl. MwSt.
488717	Werkzeugtasche 544TB	Gr. Innenfach mit 2x Fächern + 1x gr. Fach	230 x 160 x 40	187	22,50
488360 GÄNGIG	Werkzeugtasche 545TB	Gr. Innenfach mit 2x Fächern + 1x gr. Fach	200 x 300 x 180	437	25,50



544TB



545TB



Service Mappe
554TB



Mit vielen Einstecktaschen in verschiedenen Größen zur Aufbewahrung von Werkzeugen, Elastikbänder für Feinmessgeräte, 1 großem Außenfach für Dokumente 1 Einstecktasche für Notizblöcke sowie Ringösenheftmechanik.

Hesse- Art.-Nr.	Modell Herstellernr.	Maße (mm)	Gewicht (g)	UVP in € zzgl. MwSt.
488358	Service Mappe 554TB	290 x 420 x 100	995	34,30



Rolltasche
558TB



Rolltasche mit mehreren Einsteckfächern sowie einer Gummibandeinteilung. Zwei Aufhängeösen zur Befestigung an Wand oder Werkbank. Innentasche für Organisier Mod. 3449.

Hesse- Art.-Nr.	Modell Herstellernr.	Maße (mm)	Gewicht (g)	UVP in € zzgl. MwSt.
488355	Rolltasche 558TB	350 x 160 x 40	505	19,00



Service Mappe
559TB



2 Hauptfächer, gepolstertes Laptop-Fach, großes Fach für Werkzeuge. 5 Einstecktaschen für große Werkzeuge, extra Schlaufen für Kleinwerkzeuge

Hesse- Art.-Nr.	Modell Herstellernr.	Maße (mm)	Gewicht (g)	UVP in € zzgl. MwSt.
488391	Service Mappe 559TB	325 x 410 x 130	1.600	49,40



Werkzeugtasche
513000TB



Wasserdichter Kunststoffboden. Außen sind an der Tasche auf jeder Seite 3 Taschen, im Innenbereich sind es 11 Stück. Inkl. Tragegurt.

Hesse- Art.-Nr.	Modell Herstellernr.	Maße (mm)	Gewicht (g)	UVP in € zzgl. MwSt.
488341	Werkzeugtasche 513000TB	310 x 190 x 260	700	35,90



Werkzeugrucksack
563TB



Gepolsterter Rücken, zwei Hauptfächer und zwei Kleinteilfächer. Im Inneren sind viele weitere Fächer für Werkzeuge vorhanden.

Hesse- Art.-Nr.	Modell Herstellernr.	Maße (mm)	Gewicht (g)	UVP in € zzgl. MwSt.
488430	Rucksack 563TB	380 x 450 x 150	500	43,00



Werkzeugrucksack
542TB



Gepolsterter Rücken, gepolsterte einstellbare Tragegurte, gr. & kl. Innenfach + Kunststoffbox Mod. 3600 Pro mit 15 Unterteilungen.

Hesse- Art.-Nr.	Modell Herstellernr.	Maße (mm)	Gewicht (g)	UVP in € zzgl. MwSt.
488349	Rucksack 542TB	230 x 400 x 370	1.900	74,60



Absturzsicherung
TS620TB



Hesse- Art.-Nr.	Modell Herstellernr.	Max. Belas- tung (kg)	Gewicht (g)	UVP in € zzgl. MwSt.
488394	Absturzsicherung TS620TB	6,8	82	24,10

KT100TB

KT500TB



Knieschoner
KT100/500TB



Hesse- Art.-Nr.	Modell Herstellernr.	Material	Gewicht (g)	UVP in € zzgl. MwSt.
488387	Knieschoner KT100TB	E.V.A. gepolstert	237	22,30
488379	Knieschoner KT500TB	PVC-Schutz, Airlgel-Kissen	502	54,30

Handgriff mit Sicherheitsverschluss

IP66

waterproof



Befestigungsgürtel

Breite und robuste Räder

2

Sortiment

MODULARES STAPELSYSTEM PRO

Hesse-Art.-Nr.	Modell Herstellernr.	Abmessung LxBxH (mm)	Tragelast (kg)	UVP in € zzgl. MwSt.
484963	Werkzeugkoffer "M" 176005	590 x 345 x 244	20	79,40
484964	Werkzeugkoffer "L" 177002	590 x 345 x 324	20	82,80
484965 ÖÄNGIG	Werkzeugkoffer "XL" 178009	590 x 345 x 404	20	85,00
484966	MODULARES STAPEL-SYSTEM PRO 199004	590 x 345 x 960	125	393,00
484967	Metal Trolley 198892	590 x 560 x 1006	125	158,30



Werkzeugkoffer "M"



Werkzeugkoffer "L"



Werkzeugkoffer "XL"



Vollständig klappbar

Metal Trolley



Kleinteilebox
Multibox N° 1

Hesse- Art.-Nr.	Modell Herstellernr.	Abmessung LxBxH (mm)	Ausführung	UVP in € zzgl. MwSt.
484960 GÄNGIG	Multibox N° 1 301971	335 x 250 x 275	4 Kleinteileboxen No. 22 im Träger	43,70
484812	Kleinteilebox N° 22 022005	312 x 238 x 51	21 Trennstege 4 - 25 Einteilungen	8,40



Kleinteile-
box N° 22



Multibox
N° 1

484835



484832



Kleinteilebox
N° 430

Hesse- Art.-Nr.	Modell Herstellernr.	Abmessung LxBxH (mm)	Ausführung	UVP in € zzgl. MwSt.
484832	N° 430/50/25 031007	430 x 370 x 55	25 Einteilungen	29,00
484835	N° 430/80/25 032004	430 x 370 x 85	25 Einteilungen	35,50



Kleinteilebox
N° 31 - 34



Hesse- Art.-Nr.	Modell Herstellernr.	Abmessung LxBxH (mm)	Volumen (l)	UVP in € zzgl. MwSt.
484900	N° 31 131004	445 x 235 x 230	17	21,20
484901 GÄNGIG	N° 33 133978	480 x 258 x 255	22	24,80
484902	N° 34 134975	580 x 258 x 290	33	32,30



Stapelbare Eurobox
6434T

Hesse- Art.-Nr.	Modell Herstellernr.	Abmessung LxBxH (mm)	Volumen (l)	Gewicht (kg)	UVP in € zzgl. MwSt.
484984	6424T 265006	600 x 400 x 240	39	3,0	31,00
484985	6434T 266003	600 x 400 x 340	58	3,0	35,80



6434T

6424T



NLG

Werkzeugsicherung
Spin Tether™



Hesse-Art.-Nr.	Modell Herstellernr.	Max. Halte-kraft (kg)	Maße (mm)	UVP in € zzgl. MwSt.
399576	Spin Tether™ 101670	0,5	55 x 30 x 30	9,60

NLG

Haltering
Tether Loop™



Hesse-Art.-Nr.	Modell Herstellernr.	Max. Halte-kraft (kg)	Maße (mm)	UVP in € zzgl. MwSt.
399565	Tether Loop™ 101381	3,0	ø 38 (Haltering)	6,70

NLG

Haltering
360 D Ring Loop



Hesse-Art.-Nr.	Modell Herstellernr.	Max. Halte-kraft (kg)	Maße (mm)	UVP in € zzgl. MwSt.
399595	360 D Ring Loop 101363	3,0	200 x 25	7,20

NLG

Haltetape
Tether Tape™



Hesse-Art.-Nr.	Modell Herstellernr.	Max. Halte-kraft (kg)	Maße (mm)	UVP in € zzgl. MwSt.
399585 GÄNGIG	Tether Tape™ 101355	5,0	2800 x 25	33,50

NLG

Haltering
Tether Ring™



Hesse-Art.-Nr.	Modell Herstellernr.	Max. Halte-kraft (kg)	Ring ø (mm)	UVP in € zzgl. MwSt.
399550	Ø 19 mm 101466	1,0	19	1,60
399555	Ø 25 mm 101273	1,0	25	1,60
399560 GÄNGIG	Ø 38 mm 101275	1,0	38	1,80

NLG

Haltering
D Ring



Hesse-Art.-Nr.	Modell Herstellernr.	Max. Halte-kraft (kg)	Maße (mm)	UVP in € zzgl. MwSt.
399575 GÄNGIG	D Ring, groß 101362	3,0	100 x 25	6,30

NLG

Absturzsicherung

Coil Tool

Hesse- Art.-Nr.	Modell Herstellernr.	Max. Halte- kraft (kg)	Länge (mm)	UVP in € zzgl. MwSt.
399611 ÖÄNGIG	Mini 101371	1,0	0,3 - 0,95 m	14,40
399582	Leightweight 101493	1,0	0,48 - 1,8 m	16,30
399645	Spiralschlauch 101370	3,0	0,1 - 1,7 m	50,70
399552 ÖÄNGIG	Extended 101476	3,0	0,14 - 2,1 m	21,10
399583	Extended Bungee 101434	5,0	1 - 2,1 m	28,70



399582



399552



399583



399611



399645

Absturzsicherung

Bungee dehnbar

Hesse- Art.-Nr.	Modell Herstellernr.	Max. Halte- kraft (kg)	Länge (mm)	UVP in € zzgl. MwSt.
399610 ÖÄNGIG	NLG Absturzsicherung 101372	5,0	0,8 - 1,2 m	34,40



NLG

Absturzsicherung

Go™



399625

399635

Hesse- Art.-Nr.	Modell Herstellernr.	Max. Halte- kraft (kg)	Länge (m)	UVP in € zzgl. MwSt.
399625	Go™ 101552	5,0	0,25	11,30
399635 ÖÄNGIG	Go™, flexibel 101518	3,0	0,7 - 1,2	23,00

NLG

Absturzsicherung, Zubehör

Armband, Verstellbar



Hesse- Art.-Nr.	Modell Herstellernr.	Max. Halte- kraft (kg)	Maße (cm)	UVP in € zzgl. MwSt.
399680 ÖÄNGIG	Armband 101365	3,0	38 x 5	13,40

NLG

Absturzsicherung, Haltering

Tether Choke™



Hesse- Art.-Nr.	Modell Herstellernr.	Max. Halte- kraft (kg)	Maße (mm)	UVP in € zzgl. MwSt.
399600	Tether Choke™ 101368	18,0	340 x 25	17,20

NLG

Absturzsicherung, Zubehör

Automatischer Rücklauf



Hesse- Art.-Nr.	Modell Herstellernr.	Max. Halte- kraft (kg)	Länge (m)	UVP in € zzgl. MwSt.
399670	Auto. Rücklauf 101389	1,5	0,3 - 1,4	63,10



Schutzkoffer



SPEICHERKARTEN & MICRO CASES



Speicherkarten-Case

0915

Das Case bietet Platz für bis zu 12 SD-Karten, 6 Mini SD-Karten und 6 Micro SD-Karten.

Hesse- Art.-Nr.	Modell Herstellernr.	Farbe	Volumen (Liter)	Innenmaße LxBxH (mm)	Gewicht (g)	UVP in € zzgl. MwSt.
490124	0915 0910-015-110E	●	0	122 x 57 x 14	100	37,70



Schutzkoffer

Micro Cases

EIGENSCHAFTEN

- + Schutzklasse nach IP 67 wasserdicht
- + Industriestandard entsprechend, REACH-konform
- + Vorgeschnittene Schaumeinsätze optional
- + Robust, mit durchsichtigem Deckel oder bei farbigem Deckel mit Neopreneinsatz
- + Nicht rostendes Scharnier aus Edelstahl
- + Druckausgleichsventil



1010



1020



1040



M60

Hesse- Art.-Nr.	Modell Herstellernr.	Farbe	Volumen (Liter)	Innenmaße LxBxH (mm)	Gewicht (g)	UVP in € zzgl. MwSt.
489148	1010 1010-025-100E	●	0,3	111 x 73 x 43	190	20,00
489151	1020 1020-025-100E	●	0,5	135 x 90 x 43	250	25,20
489157	1040 1040-025-100E	●	0,7	165 x 98 x 44	320	33,60
489159	1050 1050-025-100E	●	1,0	203 x 129 x 79	370	37,80
489160	1060 1060-025-100E	●	2,3	251 x 142 x 67	450	42,00
489162	M40 M400-0250-100E	●	1,0	152 x 97 x 53	300	42,00
489189	M50 M500-0250-100E	●	1,2	185 x 109 x 61	400	46,20
489195	M60 M600-0250-100E	●	1,6	216 x 109 x 69	500	50,40

Auch in weiteren Farben lieferbar!

MITTLERE CASES

Mobilität mit Platz für den Schutz der etwas größeren Ausrüstung oder von mehreren Instrumenten und Zubehörteilen. Der wasserdichte, bruchsichere und staubdichte Schutzkoffer verfügt über eine O-Ring Dichtung und ein automatisches Druckausgleichsventil. Die gepolsterten Abtrennungen aus Nylon und Schaumstoff lassen sich leicht mit Velcro® zu einer individuellen Einteilung verbinden und immer wieder anpassen.



Peli Case
1200 / 1300

Hesse- Art.-Nr.	Modell Herstellernr.	Farbe	Volumen (Liter)	Innenmaße LxBxH (mm)	Gewicht (g)	UVP in € zzgl. MwSt.
488555	1200 WF 1200-000-110E	●	4,4	235 x 181 x 105	1300	95,10
488558	1300 WF 013000-0000-110E	●	6,4	233 x 178 x 155	1600	115,20

Auch in den Farben ● grau ● gelb ● orange* erhältlich. *Bitte Mindestabnahme anfragen!

1200 WF



MADE IN
GERMANY

1300 WF



MADE IN
GERMANY



Peli Case
1450 WF

Hesse- Art.-Nr.	Modell Herstellernr.	Farbe	Volumen (Liter)	Innenmaße LxBxH (mm)	Gewicht (g)	UVP in € zzgl. MwSt.
488564	1450 WF 1450-000-110E	●	14,9	374 x 260 x 154	2900	194,60

Auch in den Farben ● grau ● gelb ● orange* erhältlich. (*Bitte Mindestabnahme anfragen!)



Peli Case
1500 - 1550

Hesse- Art.-Nr.	Modell Herstellernr.	Farbe	Volumen (Liter)	Innenmaße LxBxH (mm)	Gewicht (g)	UVP in € zzgl. MwSt.
488568	1500 WF 1500-000-110E	●	18,9	428 x 286 x 155	3200	238,40
489371	1510 WF** 1510-000-110E	●	27	502 x 279 x 193	6800	322,40
489384	1510 WD** 015100-0040-110E	●	27	502 x 279 x 193	6200	386,80
488578	1550 WF 1550-000-110E	●	33	473 x 360 x 196	5400	302,30

Auch in den Farben ● grau ● gelb ● orange* erhältlich. *Bitte Mindestabnahme anfragen!
(**Ausführung mit Rollen und Teleskopgriff)

MADE IN
GERMANY

1510 WF



GROSSE CASES

Entwickelt für höchsten Schutz für Transport und Aufbewahrung. Individuell anpassbarer Innenbereich bietet extra Schutz und Gepäcksicherung. Die Modelle bieten ausziehbare Griffverlängerungen, extra breite Griffe und robuste Laufrollen für effiziente Mobilität.



Peli Case

1560 – 1690

Hesse- Art.-Nr.	Modell Herstellernr.	Farbe	Volumen (Liter)	Innenmaße LxBxH (mm)	Gewicht (g)	UVP in € zzgl. MwSt.	
489406	1560 WF** 1560-000-110E	●	44	506 x 380 x 229	9070	351,10	☞☞
489408	1560 WD** 015600-0040-110E	●	44	506 x 380 x 229	9070	470,80	☞☞
489117	1610 WF** 1610-000-110E	●	62,3	551 x 422 x 268	10.200	482,30	☞☞
489388	1610 WD** 1610-004-110E	●	62,3	551 x 422 x 268	10.200	620,10	☞☞
488591	1620 WF** 1620-000-110E	●	87,8	543 x 414 x 391	11.800	512,50	☞☞
489741	1640 WF** 016400-0000-110E	●	129,6	602 x 610 x 353	17.200	532,10	☞☞
488580	1650 WF** 1650-020-110E	●	86,1	722 x 442 x 270	12.730	524,10	☞☞
489396	1650 WD** 016500-0040-110E	●	86,1	722 x 442 x 270	12.730	709,60	☞☞
489282	1660 WF** 1660-020-110E	●	161	716 x 502 x 448	19.100	715,70	☞☞
489397	1660 WD** 1660-024-110E	●	161	716 x 502 x 448	19.100	1.040,60	☞☞
489667	1690 WF** 016900-0000-110E	●	190,3	765 x 638 x 390	19.500	756,90	☞☞



1560 WF

MADE IN
GERMANY



1650 WD

MADE IN
GERMANY

Übergröße

Auch in den Farben ● grau ● gelb ● orange* erhältlich. *Bitte Mindestabnahme anfragen!

(**Ausführung mit Rollen und Teleskopgriff)

LANGE CASES

Ideal für Waffen, wird jedoch auch von Industriefachleuten für Instrumente und Ausrüstungen genutzt. Bestückt mit robusten Polyurethan-Rollen für den problemlosen Transport.



Peli Case

1700 WF

Hesse- Art.-Nr.	Modell Herstellernr.	Farbe	Volumen (Liter)	Innenmaße LxBxH (mm)	Gewicht (g)	UVP in € zzgl. MwSt.	
489129	1700 WF 1700-000-110E	●	41,4	908 x 343 x 133	7700	458,20	↻↻
489374	1720 WF 017200-0000-110E	●	48,6	1067 x 343 x 133	8600	496,40	↻↻
489008	1740 WF 01740-0000-110E	●	105,1	1041 x 328 x 308	12.250	722,20	↻↻
489684	1780 WF 1780-000-110E	●	215,8	1044 x 547 x 378	22.230	908,80	↻↻ Übergröße

MADE IN
GERMANY



1700 WF

Auch in den Farben ● grau ● gelb ● orange* erhältlich. (*Bitte Mindestabnahme anfragen!)



Peli Case

0450 / 0340



0340 WF

Hesse- Art.-Nr.	Modell Herstellernr.	Farbe	Volumen (Liter)	Innenmaße LxBxH (mm)	Gewicht (g)	UVP in € zzgl. MwSt.	
489410	0340 WF 0340-000-110E	●	95	457 x 457 x 457	13.500	577,90	↻↻
489849	0450 004500-0610-110E	●	47	522 x 321 x 279	21.950	1.394,20	↻↻

* Ausführung mit Rollen und Teleskopgriff

PELI™ - SCHUTZKOFFER

2



Automatische Druckventile,
2 Stück – 1 pro Koffersegment



Austauschbare Rollen

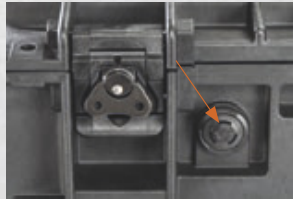

Butterfly-Verschlüsse für
höchste Verschlusssicherheit

Einzeln entnehmbare Schubladen



Verzahnter Deckel



0450 GEN II TOOLBOX

Komfortabler Trolley
mit ausziehbarem
Teleskopgriff



Das obere Fach ist größer
geworden, um den ungenutzten
Raum auszufüllen.

Das kleine Schubfach hat die
gleiche Größe aber eine neue Form
im Vergleich zur Vorgängerversion

Neues und verbessertes
Aluminium-Schiensystem
mit Vollauszug

Das große Schubfach hat die
gleiche Größe aber eine neue Form
im Vergleich zur Vorgängerversion

489849 (004500-0610-110E):
6x flache und 1x tiefe Schubladen



AIR CASES



Hesse- Art.-Nr.	Modell Herstellernr.	Farbe	Volumen (Liter)	Innenmaße LxBxH (mm)	Gewicht (g)	UVP in € zzgl. MwSt.	
490327	1535 Air WF** 015350-0003-110E	●	26,9	518 x 284 x 183	3.950	345,00	↺ ↻
490330	1535 Air TF** 015350-0052-110E	●	26,9	518 x 284 x 183	3.950	454,70	↺ ↻
490329	1535 Air WD** 015350-0043-110E	●	26,9	518 x 284 x 183	3.950	413,40	↺ ↻
490334	1555 Air TF 015550-0051-110E	●	36,1	584 x 324 x 191	3.350	520,00	
490363	1557 Air WF 015570-0001-110E	●	36,0	440 x 330 x 248	3.700	350,50	
490335	1605 Air WF 016050-0001-110E	●	50,0	660 x 356 x 213	4.220	399,30	
490392	1607 Air WD** 016070-0042-110E	●	63,4	535 x 402 x 295	7.300	598,00	↺ ↻
490342	1615 Air TF** 016150-0051-110E	●	70,5	752 x 394 x 238	6.390	755,90	↺ ↻
490393	1637 Air WF** 016370-0002-110E	●	89,4	595 x 446 x 337	8.800	553,70	↺ ↻



Teilweise auch in den Farben ● grau ● gelb ● orange* erhältlich. *Bitte Mindestabnahme anfragen!
(**Ausführung mit Rollen und Teleskopgriff)

45% TIEFER, 40% LEICHTER

Das Sortiment mit Peli™ Air Cases wurde um vier Kofferdesigns ergänzt, die 45% tiefer sind. Mit mehr als 33 cm Tiefe haben diese Peli™ Air Schutzkoffer Platz für tiefere Geräte, wie Drohnen und Videokameras.

+ PREMIUM-SCHUTZ: PELI + TREKPAK™

Das TrekPak™-System verwendet vorinstallierte Wandabschnitte, Trennwände, Sicherungsstifte und ein Schneidwerkzeug, das immer funktioniert.

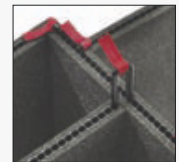

+ NEUES EINTEILERSYSTEM: PELI + DIVIDER

- Vollständig vernähte Bodenwanne mit Filz-Außenseite
- Velcro™-kompatible Nyllex™ Innenausstattung
- Elastische Spannräume
- Auffälliger gelber Innenstoff, um das Auffinden von Utensilien zu erleichtern

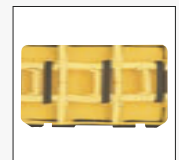

AKTUELL LIEFERBARE GRÖSSEN

HESSE-NR.	MODELL	INNENABMESSUNGEN	GEWICHT	SCHWIMMFÄHIGKEIT	FARBEN
490259	1465 AIR leer	47.3 x 25.4 x 27.8 cm	3.2 kg	37.2 kg	●
490301	1485 AIR leer	45.1 x 25.9 x 15.6 cm	2.1 kg	18.6 kg	● ●
490300	1485 AIR mit Schaumstoff	45.1 x 25.9 x 15.6 cm	2.4 kg	18.6 kg	● ●
490323	1505 AIR leer	46.5 x 33.7 x 13.9 cm	2.6 kg	24.5 kg	●
480790	1505 AIR mit Schaumstoff	46.5 x 33.7 x 13.9 cm	3.0 kg	24.5 kg	●
490667	1506 AIR leer	47.5 x 23.9 x 19.8 cm	2.4 kg	23.4 kg	●
490629	1507 AIR leer	38.5 x 28.9 x 21.6 cm	2.4 kg	24.5 kg	●
490628	1507 AIR mit Schaumstoff	38.5 x 28.9 x 21.6 cm	2.9 kg	24.5 kg	●
490308	1525 AIR leer	52.1 x 28.7 x 17.1 cm	2.7 kg	26.3 kg	● ●
490305	1525 AIR mit Schaumstoff	52.1 x 28.7 x 17.1 cm	3.2 kg	26.3 kg	●
490328	1535 AIR leer	51.8 x 28.4 x 18.3 cm	3.9 kg	29.4 kg	● ● ● ●
490327	1535 AIR mit Schaumstoff	51.8 x 28.4 x 18.3 cm	4.5 kg	29.4 kg	●
490332	1555 AIR leer	58.4 x 32.4 x 19.1 cm	3.3 kg	36.8 kg	●
490331	1555 AIR mit Schaumstoff	58.4 x 32.4 x 19.1 cm	4.1 kg	36.8 kg	●
490662	1556 AIR leer	54.9 x 27.3 x 22.8 cm	4.4 kg	38.5 kg	●
490364	1557 AIR leer	44.0 x 33.0 x 24.8 cm	3.0 kg	36.3 kg	●
490363	1557 AIR mit Schaumstoff	44.0 x 33.0 x 24.8 cm	3.7 kg	36.3 kg	●
490762	1595 AIR leer	65.0 x 38.2 x 22.9 cm	6.2 kg	67.3 kg	●
490761	1595 AIR mit Schaumstoff	65.0 x 38.2 x 22.9 cm	7.4 kg	67.3 kg	●
490336	1605 AIR leer	66.0 x 35.6 x 21.3 cm	4.2 kg	51.2 kg	● ●
490335	1605 AIR mit Schaumstoff	66.0 x 35.6 x 21.3 cm	5.3 kg	51.2 kg	●
490664	1606 AIR leer	62.3 x 31.2 x 26.0 cm	5.6 kg	56.1 kg	●
490381	1607 AIR leer	53.5 x 40.2 x 29.5 cm	6.0 kg	80.7 kg	● ● ● ●
490380	1607 AIR mit Schaumstoff	53.5 x 40.2 x 29.5 cm	6.7 kg	80.7 kg	●
490340	1615 AIR leer	75.2 x 39.4 x 23.8 cm	6.4 kg	76.7 kg	● ●
490339	1615 AIR mit Schaumstoff	75.2 x 39.4 x 23.8 cm	6.7 kg	76.7 kg	●
490759	1626 AIR leer	71.5 x 35.8 x 29.8 cm	6.6 kg	84.1 kg	●
490394	1637 AIR leer	59.5 x 44.6 x 33.7 cm	6.9 kg	94.8 kg	● ● ● ●
490393	1637 AIR mit Schaumstoff	59.5 x 44.6 x 33.7 cm	8.8 kg	94.8 kg	●
490683	1646 AIR leer	81.4 x 40.3 x 34.1 cm	9.3 kg	119.3 kg	●
489039	1745 AIR leer	111.8 x 42.6 x 20.3 cm	7.8 kg	98.4 kg	●
489017	1745 AIR mit Schaumstoff	111.8 x 42.6 x 20.3 cm	9.6 kg	98.4 kg	●
489904	1755 AIR leer	139.7 x 35.6 x 20.3 cm	9.1 kg	-	●
489903	1755 AIR mit Schaumstoff	139.7 x 35.6 x 20.3 cm	11.3 kg	-	●

+ DECKELEINTEILER

Aus Kunstleder oder wasserfestem, ballistischem Nylon mit Nylon-Reißverschlüssen hergestellt. Eine große Vielfalt an Taschen in unterschiedlichen Größen schützen Ihre Ausrüstung und sorgen für Ordnung. Der Einbau erfolgt problemlos mit Velcro® Klettstreifen (enthalten).



OPTIONEN FÜR DECKELEINTEILER				
KOFFER	MESH	COMPUTER	FOTO	EMS
1430				
1440	1449 Mesh ^A		1439 Foto ^A	
1490		1498 Computer ^B		
1495		1495 Computer ^B		
1500	1509 Mesh		1508 Foto	1505 EMS ^B
1510	1519 Mesh ^A			
1520	1509 Mesh		1508 Foto ^B	
1550				1555 EMS ^B
1560	1569 Mesh			
1600	1609 Mesh ^B			1605 EMS ^A
1610	1609 Mesh ^B			
1620	1609 Mesh ^B			
1630	1639 Mesh ^A			
1640	0379 Mesh ^A			
1650	1659 Mesh ^A			
1660	1669 Mesh ^A			
1690	1699 Mesh ^A			
0340	0349 Mesh ^A			
0350	0359 Mesh ^A			
0370	0379 Mesh ^A			

A= Mit Befestigungsschrauben B= Mit Befestigungs-Velcro®

+ EZ-CLICK™ MOLLE-DECKELEINLAGE

Die erste Kofferdeckeleinlage, die schnell und ohne Werkzeuge herausgenommen und ausgetauscht werden kann. Die Deckeleinlage wurde für den Pelli-Schutzkoffer 1560 entwickelt und ist kompatibel mit benutzereigenen MOLLE-Taschen und Klettverschlüssen.



+ GEPOLSTERTE ABTRENUNGEN

Eine Alternative zu dem Pelli™ Schaumstoff sind unsere optionalen gepolsterten Abtrennungen. Diese haltbaren Abtrennungen aus Nylon und Schaumstoff sind extrem vielseitig. Die Fächer werden mit Velcro® verbunden, so dass Sie die Konfigurationen problemlos nach Ihren Bedürfnissen ändern können.



OPTIONEN FÜR GEPOLSTERTE ABTRENUNGEN			
KOFFER	EINLAGEN	KOFFER MIT ABTRENUNGEN (KAT. NR.)	ABTRENUNG NUR IM SET (KAT. NR.)
1450	1	1454	1455
1500	1	1504*	1505*
1510	1	1514*	1515*
1520	1	1524	1525
1550	1	1554*	1555*
1560	1	1564*	1565*
1600	1	1604	1605
1610	1	1614	1615
1620	2	1624	1625
1630	2	1634	1635
1640	2	1644	1645
1650	1	1654*	1655*
1660	2	1664	1665
1690	2	1694	1695
0340	2	0344	0345
0350	2	0354	0355
0370	2	0374	0375



Diese Schutzkoffer/Sets werden inklusive der NEUEN, hoch sichtbaren gelben Trennwände geliefert. Alle anderen Koffer/Sets werden mit den schwarzen Standard-Trennwänden geliefert.

+ HYBRIDER SCHUTZ

Sie müssen keine Entscheidung mehr treffen zwischen der Vielseitigkeit des TrekPak™-Trennsystems und dem individuellen Schutz des anpassbaren Pick N Pluck™-Schaumstoffs. Mit dem Pelli™ Air Hybrid-Schutz können Sie einfach beides nutzen. Nur im Pelli™-Schutzkoffer 1510 standardmäßig enthalten.







3

SICHERHEIT IN EUROPA

VERFÜGT MEINE TASCHENLAMPE ÜBER
DIE KORREKTE ATEX ZERTIFIZIERUNG?

CE  II 1G EX IA OP IS IIC T4 GA

* ATEX Code entspricht dem 1975Z0 Lampenmodell

Sie benötigen weitere Informationen
zu ATEX?

Bitte besuchen Sie www.peli.com/atex



+ VERGLEICH ZWISCHEN US (UL, FM) UND EUROPÄISCHER (ATEX) KLASSIFIZIERUNG

Laden Sie unser Poster zur ATEX-Richtlinie 2014/34/EU herunter



RICHTLINIEN FÜR ELEKTRISCHE GERÄTE IN EXPLOSIONSGEFÄHRDETEN BEREICHEN					
	SUBSTANZ	TYPISCHE UMGEBUNGEN	US-KLASSIFIZIERUNGEN	EUROPÄISCHE KLASSIFIZIERUNG	FLÜCHTIGKEIT*
KLASSE I	Entzündbare Gase, Dämpfe oder Flüssigkeit (Acetylen, Wasserstoff, Ethylen, Propan)	– Erdölraffinerie – – Farblager – – Offshore Bohrinselfn – – Spritzkabinen –	Division 1 (Wahrscheinliches Risiko)	Kategorie 1 / Zone 0 (Risiko vorhanden)	MAXIMUM ↑ ↓ MINIMUM
			Division 2 (Unwahrscheinliches Risiko)	Kategorie 2 / Zone 1 (Wahrscheinliches Risiko) Kategorie 3 / Zone 2 (Unwahrscheinliches Risiko)	
KLASSE II	Brennbare Stäube (Metalle [nur Div.1], Kohle, Getreide)	– Kohlengrube – – Getreidesilo – – Munitionsfabrik – – Heulager –	Division 1 (Wahrscheinliches Risiko)	Kategorie 1 / Zone 20 (Risiko vorhanden) Kategorie 2 / Zone 21 (Wahrscheinliches Risiko)	
			Division 2 (Unwahrscheinliches Risiko)	Kategorie 3 / Zone 22 (Unwahrscheinliches Risiko)	
KLASSE III	Entflammare Fasern & Flusen (Bearbeitetes Magnesium)	– Papierfabrik – – Holzbearbeitung – – Textilfabrik – – Entkörnungsmaschine für Baumwolle –	Division 1 (Wahrscheinliches Risiko)	N.vorh.	
			Division 2 (Unwahrscheinliches Risiko)	N.vorh.	

* Eine nach Kategorie 1 (Zone 0) zertifizierte Taschenlampe ist sicher für die Verwendung in Bereichen, die nach Kategorie 2 (Zone 1) und Kategorie 3 (Zone 2) eingestuft wurden. Eine Umkehrung ist nicht möglich. Diese Information sollte nur als Richtlinie betrachtet werden. Kontaktieren Sie uns, wenn Sie spezifische Einzelheiten zu den amerikanischen und europäischen Richtlinien benötigen.

+ DIAGRAMM MIT KLASSEN / DIVISIONEN / ZONEN

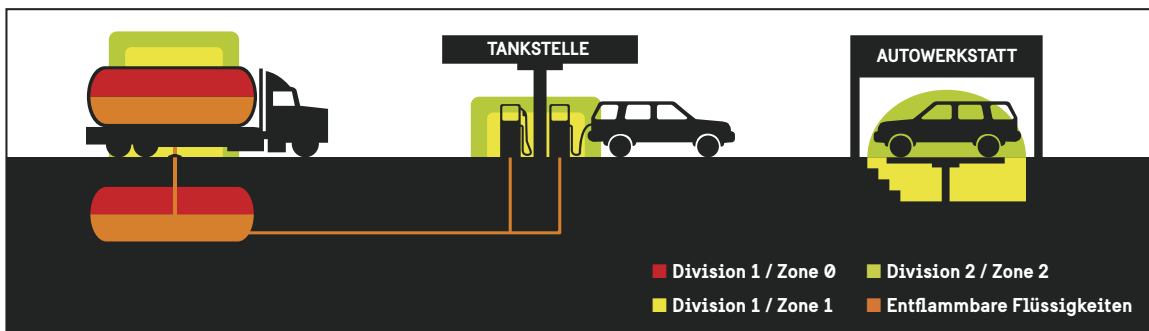



ATEX LAMPEN

Zone 0 & 1 (Cat. 1 & 2)

Die Peli Serie der Zonen 0 und 1 Lampen erfüllen die Normen der ATEX-Richtlinie und entsprechen den IEC (International Electrotechnical Commission) Anforderungen. Diese Lampen wurden speziell für den Einsatz in Gefahrenzonen entwickelt. Somit können Profis, die in der Pharma-, Brandbekämpfungs-, Rettungs-, Gefahrengutbranche oder anderen Bereichen mit hohem Risikopotential arbeiten, darauf vertrauen, dass Peli die Sicherheitszulassungen bietet, die für eine Vielzahl an Gefahrenumgebungen erforderlich sind.

3



EX-Taschenlampe

1975Z0 / 2315Z0 LED IP68



Hesse-Art.-Nr.	Modell Herstellernr.	☀️	🔦	🔋	UVP in € zzgl. MwSt.
488421	1975Z0	117 lm	24 m	2x AAA	39,60
GÄNGIG	019750-0301-241E				
488485	2315Z0	115lm	50 m	2x AA	57,20
	023150-0100-241E				



EX-Taschenlampe

1975Z1 LED IP68



Hesse-Art.-Nr.	Modell Herstellernr.	☀️	🔦	🔋	UVP in € zzgl. MwSt.
488432	1975Z1	94 lm	22 m	2x AAA	33,30
	019750-0201-241E				



EX-Taschenlampe

StealthLite™ 2410Z0 LED IPX7



Hesse-Art.-Nr.	Modell Herstellernr.	☀️	🔦	🔋	UVP in € zzgl. MwSt.
489367	2410Z0	153 lm	165 m	4x AA	138,30
	024100-0001-241E				



EX-Taschenlampe

3315Z0 LED IP67



Hesse-Art.-Nr.	Modell Herstellernr.	☀️	🔦	🔋	UVP in € zzgl. MwSt.
491001	3315Z0	138 lm	146 m	3x AA	76,70
GÄNGIG	033150-0102-241E				



EX-Taschenlampe
3415Z0M



Hesse- Art.-Nr.	Modell Herstellernr.				UVP in € zzgl. MwSt.
489533	3415Z0M 034150-0303-241E	329 lm	134 m	3x AA	110,60



EX-Taschenlampe
3335RZ0



Hesse- Art.-Nr.	Modell Herstellernr.				UVP in € zzgl. MwSt.
491008	3335RZ0 03335R-0001-241E	246 lm	151 m	Li-Ion Akku	241,90
491020	3317 Winkeladapter (zu 3335RZ0) 03315R-3030-000				48,35



EX-Taschenlampe
3765Z0



Hesse- Art.-Nr.	Modell Herstellernr.				UVP in € zzgl. MwSt.
489693	3715Z0 037150-0001-241E	189 lm	249 m	4x AA	254,60
489748	3765Z0 037650-0001-241E	194 lm	256 m	NiMH Akku	379,10



Taktische Taschenlampe LED
7060/8060



Hesse- Art.-Nr.	Modell Herstellernr.				UVP in € zzgl. MwSt.
489495	7060 070600-0001-110E	535 lm	210 m	Li-Ion Akku	380,30
489369	8060 080600-0001-110E	1072 lm	376 m	NiMH Akku	397,30



EX-Arbeitsleuchte
9415Z0



Hesse- Art.-Nr.	Modell Herstellernr.				UVP in € zzgl. MwSt.
490224	9415Z0 9415-003-241E	530 lm	272 m	NiMH Akku	853,10



EX-Kopflampe

2610Z0/2690Z0 HeadsUp Lite™



2610Z0



2690Z0



Demnächst
auch mit
gelbem
Lampenkopf
erhältlich

Hesse- Art.-Nr.	Modell Herstellernr.				UVP in € zzgl. MwSt.
489451	2610Z0 2610-035-110E	30 lm	28 m	3x AAA	61,60
489874	2690Z0 026900-0102-110E	74 lm	92 m	3x AAA	70,40



EX-Kopflampe

2745Z0 - 2765Z0



2745Z0



2755Z0



2765Z0

Hesse- Art.-Nr.	Modell Herstellernr.				UVP in € zzgl. MwSt.
489512	2745Z0 027450-0104-241E	33 lm	35 m	3x AAA	75,40
489513	2755Z0 GÄNGIG 027550-0104-241E	115 lm	61 m	3x AAA	83,00
489531	2765Z0 GÄNGIG 027650-0104-241E	141 lm	78 m	3x AAA	89,90

3



Beleuchtungssystem

9455Z0



Hesse- Art.-Nr.	Modell Herstellernr.				UVP in € zzgl. MwSt.
490160	9455Z0 GÄNGIG 094550-0000-245E	1600 lm	10 Std.	Akku	2.433,60



Peli Case

1460 mit AALG-Einteiler leer/bestückt mit 9455Z0

Hesse- Art.-Nr.	Modell Herstellernr.	Inhalt	Volumen (Liter)	Innenmaße LxBxH (mm)	Gewicht (g)	UVP in € zzgl. MwSt.
490203	1460 AALG 1460-006-110E	mit Schaumeinsatz	33	471 x 252 x 277	5.660	424,00
490905	9455Z0/1460	Koffer + 9455Z0	33	471 x 252 x 277	13.000	2.857,60





Beleuchtungssystem
9430



489548



490152



Um 360°
drehbar

Hesse- Art.-Nr.	Modell Herstellernr.				UVP in € zzgl. MwSt.
490152	9430	3000	15 Std.	Akku	1.037,30
GÄNGIG	094300-0001-245E	lm			
489548	9430	3000	15 Std.	Akku	1.037,30
	094300-0001-110E	lm			



Beleuchtungssystem
9490



490226



490225

Hesse- Art.-Nr.	Modell Herstellernr.				UVP in € zzgl. MwSt.
490226	9490	6000	24 Std.	Akku	1.239,80
	094900-0000-245E	lm			
490225	9490	6000	24 Std.	Akku	1.239,80
	094900-0000-110E	lm			



Beleuchtungssystem
9730



1 m
ausfahrbar

Hesse- Art.-Nr.	Modell Herstellernr.				UVP in € zzgl. MwSt.
490898	9730	4.800	13 Std.	Akku	580,00
NEU	097300-0000-245E	lm			



Beleuchtungssystem
9750



9750Z0 schwarz



9750Z0 gelb



1 m
ausfahrbar

8 Licht-
modi

Hesse- Art.-Nr.	Modell Herstellernr.				UVP in € zzgl. MwSt.
490899	9750Z0 schwarz	8.250	24 Std.	Akku	887,00
NEU	097500-000-110E	lm			
490900	9750Z0 gelb	8.250	24 Std.	Akku	887,00
NEU	097500-0000-245E	lm			



Koffer-Beleuchtungssystem
MPV01 ModLight Pivot



USB-C

Hesse- Art.-Nr.	Modell Herstellernr.				UVP in € zzgl. MwSt.
490910	MPV01	140	18 Std.	Akku	74,30
NEU	MPV01-0000-110	lm			



Lampen

3





Q1mini

Q1

Q1 TRUE COLOR

Q1r

LIGHT ANGLE GUIDE

suprabeam®

LED Taschenlampe
Q1mini



LED IPX4



suprabeam®

LED Taschenlampe
Q1/Q1r



LED IPX4



Hesse- Art.-Nr.	Modell Herstellernr.				UVP in € zzgl. MwSt.
488777 GÄNGIG	Q1mini 501.2011	30 - 120 lm	60 m	1x AAA	37,60

Hesse- Art.-Nr.	Modell Herstellernr.				UVP in € zzgl. MwSt.
488778 GÄNGIG	Q1 501.3111	40 - 160 lm	70 m	2x AAA	39,00
488840	Q1r 501.5011	6 - 550 lm	100 m	1x Li-Po 720 mAh	69,00

suprabeam®

LED Taschenlampe

Q2



LED IPX4



Hesse- Art.-Nr.	Modell Herstellernr.				UVP in € zzgl. MwSt.
488773	Q2	40 - 200 lm	150 m	1x AA	59,00
GÄNGIG	502.1011				

suprabeam®

LED Taschenlampe

Q2xr USB-C



LED IPX4

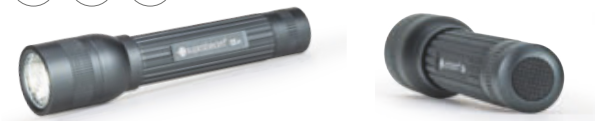

Hesse- Art.-Nr.	Modell Herstellernr.				UVP in € zzgl. MwSt.
488898	Q2xr	6 - 800 lm	175 m	1x Li-Po 1100 mAh	99,00
	502.6011				

suprabeam®

LED Taschenlampe

Q3



LED IPX4



Hesse- Art.-Nr.	Modell Herstellernr.				UVP in € zzgl. MwSt.
488779	Q3	10 - 380 lm	50 m	3x AAA	69,00
GÄNGIG	503.1111				



suprabeam®

LED Taschenlampe

Q3r USB-C



LED IP68



Hesse- Art.-Nr.	Modell Herstellernr.				UVP in € zzgl. MwSt.
489095	Q3r	6 - 1100 lm	200 m	1x Li-Po 3000 mAh	129,00
GÄNGIG	503.5311				

suprabeam®

LED Taschenlampe

Q7xrs USB-C



LED IPX4



Hesse- Art.-Nr.	Modell Herstellernr.				UVP in € zzgl. MwSt.
489355	Q7xrs	6 - 2000 lm	345 m	1x Li-Ion 5000 mAh	239,00
	507.6205				

3



Wasserdicht - Ein Produkt mit der IP68 Schutzart ist wasserdicht bis auf 2 Meter Tiefe.





LED Multilampe
M6r/M6xr USB-C



Hesse- Art.-Nr.	Modell Herstellernr.				UVP in € zzgl. MwSt.
488815 GÄNGIG	M6r 526.5011	6 - 600 lm	150 m	1x Li-Ion, 3000 mAh	80,00
489259 GÄNGIG	M6xr 526.6111	6 - 2000 lm	165 m	1x Li-Ion, 3000 mAh	149,00

IPx8

IP68



Die M6xr beinhaltet alle Befestigungsoptionen der Taschen- und Stirnlampen kombiniert.



LED Kopflampe
V3pro rechargeable



Hesse- Art.-Nr.	Modell Herstellernr.				UVP in € zzgl. MwSt.
488789 GÄNGIG	V3pro rech. 612.5211	6 - 1000 lm	245 m	1x Li-Po, 2800 mAh	139,00



LED Kopflampe
V3air / rechargeable



488794

Hesse- Art.-Nr.	Modell Herstellernr.				UVP in € zzgl. MwSt.
488792	V3air 610.1011	6 - 340 lm	195 m	3x AAA	69,00
488794	V3air rech. 610.5211	6 - 650 lm	210 m	1x Li-Po	99,00



LED Kopflampe
V7 rechargeable



Hesse- Art.-Nr.	Modell Herstellernr.				UVP in € zzgl. MwSt.
489929 NEU	V7 rech. 617.5011	40 - 3500 lm	180 m	1x Li-Ion, 5000 mAh	275,00



Ersatzakku
M6-Serie/V3pro & V4pro



489263

489869

Hesse- Art.-Nr.	Modell Herstellernr.	Akku	UVP in € zzgl. MwSt.
489263	Akku USB-C M6-Serie 951.029	Li-Ion Akku 18650 (3000 mAh)	34,00
489869	Akku USB-C V3pro & V4pro 951.028	Li-Ion Akku 154250 (2800 mAh)	39,00

3

suprabeam®

LED Arbeitslampe
I2r / I4r



Hesse- Art.-Nr.	Modell Herstellernr.				UVP in € zzgl. MwSt.
488832	I2r 410.1002	700 lm	16 Std.	1x Li-ion, 2600 mAh	74,00
488833	I4r 410.1001	1000 lm	4,25 Std.	1x Li-ion, 3350 mAh	78,00

suprabeam®

LED Arbeitslampe
D2r / D4r



Hesse- Art.-Nr.	Modell Herstellernr.				UVP in € zzgl. MwSt.
488834	D2r 410.1101	700 lm	120 m	1x Li-ion, 2600 mAh	65,00
488835	D4r 410.1102	1400 lm	125 m	1x Li-ion, 5200 mAh	89,00

suprabeam®

LED Arbeitslampe
W2r / W4r / W6r



Hesse- Art.-Nr.	Modell Herstellernr.				UVP in € zzgl. MwSt.
488837	W2r 410.1201	2200 lm	11 Std.	1x Li-ion, 5200 mAh	159,00
488838	W4r 410.1202	4400 lm	6,5 Std.	1x Li-ion, 5200 mAh	219,00
488839	W6r 410.1302	4600 lm	14 Std.	1x Li-ion, 5200 mAh	229,00



488837

488838



488839



Leica DISTO™ und Leica Lino

JEDER AUFGABE GEWACHSEN





Preise Leica DISTO™



	DISTO™ D1	DISTO™ D2-2	DISTO™ D2G	DISTO™ D5	DISTO™ X1	DISTO™ X3	DISTO™ X6
Hesse-Nr.	470605	470583	470584	470531	470659	470621	470648
Hersteller-Nr.	843418	986858	1017808	950908	986859	850833	950909
Distanzmessung	bis zu 40 m	bis zu 150 m	bis zu 120 m	bis zu 200 m	bis zu 100 m	bis zu 150 m	bis zu 250 m
Genauigkeit	± 2 mm	± 1,5 mm	± 1,5 mm	± 1 mm	± 1,5 mm	± 1 mm	± 1 mm
UVP (zzgl. MwSt.)	115,00 €	220,00 €	250,00 €	490,00 €	169,00 €	317,00 €	614,00 €

4

Sortimente Leica DISTO™



	Disto™ D5 Paket	Disto™ X6 P2P Paket
Hesse-Nr.	470532	470649
Hersteller-Nr.	950879	950878
Lieferumfang	<ul style="list-style-type: none"> • Laserdistanzmessgerät Leica DISTO™ D5 • Tasche • Adapter FTA 360 • Stativ TRI 75 • USB Ladegerät • USB-C-Kabel • Koffer (MetaBox) • Kurzanleitung, Sicherheitshinweise, Kalibrierzertifikat „silber“, Garantiekarte 	<ul style="list-style-type: none"> • Laserdistanzmessgerät Leica DISTO™ X6 • Tasche • Adapter DST 360-X • Stativ TRI 120 • USB-Ladegerät • USB-C-Kabel • Zieltafel GZM 3 • Koffer (MetaBox) • Kurzanleitung, Sicherheitshinweise, Kalibrierzertifikat „silber“, Garantiekarte
UVP (zzgl. MwSt.)	819,00 €	1.469,00 €

Preise Leica Lino



GÄNGIG



	L2	L2G	L2P5	L2P5G	L4P1
Hesse-Nr.	470625	470626	470628	470629	470552
Hersteller-Nr.	864413	864420	864431	864435	834838
Farbe des Laserlichts	●	●	●	●	●
Reichweite	bis zu 25 m	bis zu 35 m	bis zu 25 m	bis zu 35 m	bis zu 15 m
Nivelliergenauigkeit	± 0,2 mm	± 0,2 mm	± 0,2 mm	± 0,2 mm	± 0,2 mm
Betriebsdauer	bis zu 44 Std. (Li-Ion)	bis zu 28 Std. (Li-Ion)	bis zu 44 Std. (Li-Ion)	bis zu 28 Std. (Li-Ion)	bis zu 24 Std. (Li-Ion)
UVP (zzgl. MwSt.)	275,00 €	449,00 €	449,00 €	624,00 €	599,00 €

Sortimente Leica Lino

Einsteigerpakete



	Leica Lino L6Rs	Leica Lino L6R	Leica Lino L6Gs	Leica Lino L6G
Hesse-Nr.	470566	470563	470564	470558
Hersteller-Nr.	918976	912969	918977	912971
Reichweite	bis zu 25 m	bis zu 35 m	bis zu 25 m	bis zu 35 m
Nivelliergenauigkeit	± 0,2 mm	± 0,2 mm	± 0,2 mm	± 0,2 mm
Betriebsdauer	bis zu 25 Std. (AA)	bis zu 36 Std. (Li-Ion)	bis zu 11 Std. (Li-Ion)	bis zu 11 Std. (Li-Ion)
Lieferumfang	<ul style="list-style-type: none"> • Leica Lino L6R • Gürteltasche • 3x AA Batterien • Alkaline Batteriefach • Zieltafel 	<ul style="list-style-type: none"> • Leica Lino L6R • Robuster Koffer • Lithium-Ionen-Akku inkl. Ladegerät und Stecker • Alkaline Batteriefach • Zieltafel • Magnetischer Multifunktionsadapter TWIST 250 • UAL 130 Adapter 	<ul style="list-style-type: none"> • Leica Lino L6G • Gürteltasche • Lithium-Ionen-Akku inkl. Ladegerät und Stecker • Alkaline Batteriefach • Zieltafel 	<ul style="list-style-type: none"> • Leica Lino L6G • Robuster Koffer • Lithium-Ionen-Akku inkl. Ladegerät und Stecker • Alkaline Batteriefach • Zieltafel • Magnetischer Multifunktionsadapter TWIST 250 • UAL 130 Adapter
UVP (zzgl. MwSt.)	419,00 €	634,00 €	624,00 €	725,00 €

4



Das Originalzubehör

Leica DISTO™ und Lino

Adapter zur Messung von Punkt zu Punkt (P2P).



Adapter DST 360 Adapter DST 360-X Adapter FTA 360

Hesse-Nr.	470651	470652	470597
Hersteller-Nr.	864982	946095	799301
Ausführung	Für Leica DISTO™ X3	Für Leica DISTO™ X6	Für Leica DISTO™ D5
UVP (zzgl. MwSt.)	599,00 €	665,00 €	215,00 €



Stativ TRI 75 Stativ TRI 120 Stativ TRI 200

Hesse-Nr.	470591	470617	470599
Hersteller-Nr.	975718	848788	828426
Ausführung	Ausziehbar von 0,42 - 1,15 m	Ausziehbar bis 1,16 m	Ausziehbar von 0,75 - 1,15 m
UVP (zzgl. MwSt.)	95,00 €	169,00 €	139,00 €

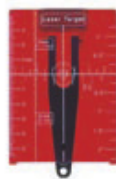

Für den Trockenbau

Zieltafel (roter Laser) Zieltafel (grüner Laser) Empfänger RGR 200 Adapter UAL 130

Hesse-Nr.	470592	470653	470635	470633
Hersteller-Nr.	758831	823195	866090	866131
Ausführung	● 150 x 74 mm	● 150 x 74 mm	Für Leica Linos L2, L2G, L2P5, L2P5G, L4P1, L6R und L6G	Für Leica Linos P5, L2, L2G, L2P5, L2P5G, L6R und L6G
UVP (zzgl. MwSt.)	17,00 €	17,00 €	180,00 €	84,00 €

4



4

Hultafors



Gliedermaßstab
Schwedenmeter



Hesse- Art.-Nr.	Modell Herstellernr.	Messbe- reich (m)	Anzahl d. Glieder	Material	UVP in € zzgl. MwSt.
480205 GÄNGIG	59-2-10 100004	2	10	Holz	7,60
480210	59-2-12 100104	2	12	Holz	8,70
480208	59-2,4-12 100304	2,4	10	Holz	9,20
480220	59-1-6 100204	2	6	Holz	5,00

59-2-10



59-2-12



59-2,4-12



59-1-6



4



Gliedermaßstab
Schwedenmeter (inch)

inch

61-1-6



61-2-10



Hesse- Art.-Nr.	Modell Herstellernr.	Messbe- reich (m)	Anzahl d. Glieder	Material	UVP in € zzgl. MwSt.
480364	61-1-6 100504	1	6	Holz	5,10
480366	61-2-10 100504	2	10	Holz	7,90

Gliedermaßstab
Contact-Meter



Hesse- Art.-Nr.	Modell Herstellernr.	Messbe- reich (m)	Anzahl d. Glieder	Material	UVP in € zzgl. MwSt.
480247	559-2-10 101804	2	10	Holz	7,90

Mit gegenläufiger Skalierung



Gliedermaßstab

Schwindmaß 1%

Hesse- Art.-Nr.	Modell Herstellernr.	Messbe- reich (m)	Anzahl d. Glieder	Material	UVP in € zzgl. MwSt.
480240	590-2-10 103104	2	10	Holz	21,50

Schrumpfskala in Rotdruck



Gliedermaßstab

Hessemeter



Hesse- Art.-Nr.	Modell Herstellernr.	Messbe- reich (m)	Anzahl d. Glieder	Material	Farbe	UVP in € zzgl. MwSt.
480260 GÄNGIG	260-2-10 105154	2	10	Holz	○	4,20
480265	265-2-10 105354	2	10	Holz	●	4,20
480270	270-2-10 105254	2	10	Holz	◐	4,40

260-2-10



265-2-10



270-2-10



Gliedermaßstab

Blockmeter

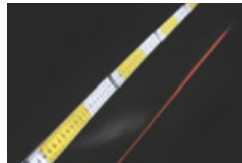

Hesse- Art.-Nr.	Modell Herstellernr.	Messbe- reich (m)	Anzahl d. Glieder	Material	Farbe	UVP in € zzgl. MwSt.
480437	337-2-10	2	10	Holz	◐	4,50
480333	333-2-10	2	10	Holz	●	3,90
480301	301-2-10	2	10	Holz	○	4,90

337-2-10 - gelb - weiss



333-2-10 - gelb



301-2-10 - weiß



Gliedermaßstab

Kunststoffmeter



Hesse- Art.-Nr.	Modell Herstellernr.	Messbe- reich (m)	Anzahl d. Glieder	Material	Farbe	UVP in € zzgl. MwSt.
480387	G59-1-10 200364	1	10	Kunst- stoff	○	6,90
480385	G59-2-10 200064	2	10	Kunst- stoff	○	7,80
480378	G59-2-10 200004	2	10	Kunst- stoff	●	8,00

G59-1-10 - weiss



G59-2-10 - weiss



G59-2-10 - gelb



DER WERBEBOTSCHAFTER

Wenn Qualität Ihr Maßstab ist

Erhöhen Sie die Sichtbarkeit Ihres Unternehmens und hinterlassen Sie den perfekten Eindruck auf einem hochwertigen Werbemittel.



Vom Entwurf bis zum fertigen Produkt erhalten Sie bei uns alles **aus einer Hand**. Dadurch garantieren wir Ihnen **kurze Lieferzeiten** und höchste Qualität zu einem **fairen Preis**.



Anschlagdreieck
MRS / LMRS

Hesse- Art.-Nr.	Modell Herstellernr.	Material	Länge (mm)	Gewicht (g)	UVP in € zzgl. MwSt.
483271	MRS	Aluminum	180	220	20,50
GÄNGIG	257010				
483288	LMRS	Aluminum	300	620	37,00
	257040				

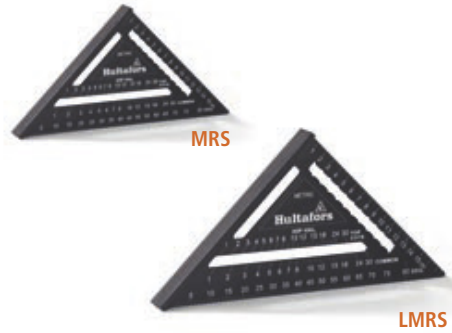

Winkelschmiege
SLB-20



Hesse- Art.-Nr.	Modell Herstellernr.	Material	Länge (mm)	Gewicht (g)	UVP in € zzgl. MwSt.
480435	SLB-20 256013	Aluminum	268	170	48,80



Messwinkel
QUATTRO 270 / Professional S25P

Hesse- Art.-Nr.	Modell Herstellernr.	Material	Länge (mm)	Gewicht (g)	UVP in € zzgl. MwSt.
480391	QUATTRO 270 253120	Edelstahl / Aluminum	300	260	50,10
480406	Professional S25P 260403	Edelstahl / Aluminum	250	300	33,70





Bandmaß
Talmeter



Hesse- Art.-Nr.	Modell Herstellernr.	Bandbreite (mm)	Mess- klasse	Gewicht (g)	UVP in € zzgl. MwSt.
483115 GÄNGIG	2 m 359103	16	EG II	121	21,20
483117	Ersatzband 2 m 359111	16	EG II	38	10,90
483120 GÄNGIG	3 m 359203	16	EG II	155	27,00
483122	Ersatzband 3 m 359211	16	EG II	58	14,70
483110	6 m 359303	25	EG II	417	53,60
483123	Ersatzband 6 m 359311	25	EG II	170	26,30



2 m / 16 mm



Ersatzband 2 m



6 m / 25 mm



Ersatzband 6 m

class II



Bandmaß
TK

class II



3 m / 13 mm

5 m / 19 mm

Hesse- Art.-Nr.	Modell Herstellernr.	Bandbreite (mm)	Mess- klasse	Gewicht (g)	UVP in € zzgl. MwSt.
483126	3 m 367003	13	EG II	130	7,00
483127	5 m 367103	19	EG II	250	13,70



Bandmaß
BT



5 m / 19 mm

class I

Hesse- Art.-Nr.	Modell Herstellernr.	Bandbreite (mm)	Mess- klasse	Gewicht (g)	UVP in € zzgl. MwSt.
480289	5 m 356103	19	EG I	295	29,40
480308	8 m 356203	25	EG I	505	40,50





Bandmaß
TMC



Hesse- Art.-Nr.	Modell Herstellernr.	Bandbreite (mm)	Mess- klasse	Gewicht (g)	UVP in € zzgl. MwSt.
480278	3 m 368003	13	EG I	114	14,20
480285	5 m 368103	19	EG I	228	26,40
480294	8 m 368203	25	EG I	442	40,10
480298	10 m 368303	25	EG I	552	46,20



3 m / 13 mm



10 m / 13 mm



Bandmaß
PR



3 m / 19 mm

5 m / 19 mm

Hesse- Art.-Nr.	Modell Herstellernr.	Bandbreite (mm)	Mess- klasse	Gewicht (g)	UVP in € zzgl. MwSt.
483129	3 m 350103	19	EG I	154	19,40
483130	5 m 350203	19	EG I	235	26,90
483131	8 m 350303	25	EG I	367	38,40



Bandmaß
CC



5 m / 19 mm

Hesse- Art.-Nr.	Modell Herstellernr.	Bandbreite (mm)	Mess- klasse	Gewicht (g)	UVP in € zzgl. MwSt.
483132	10 m 390103	10	EG I	190	35,60
483134	20 m 390203	10	EG I	307	43,50
483136	30 m 390303	10	EG I	469	55,40



Hultafors

Der Trockenmarker

Jetzt auch mit Ihrem Logo erhältlich!

Der grifffreundliche Stift im Holster mit integriertem Anspitzer für klare Markierungen.



Mit integriertem
Anspitzer im Köcher



Praktisches Nachfüllset



In diesen Farben erhältlich

Individueller
Werbeaufdruck
ab 200 Stk.
möglich.



Trockenmarker für den Werbedruck (ab 200 Stück)

HDM



Hesse- Art.-Nr.	Modell Herstellernr.	Länge d. Mine (mm)	Stärke d. Mine (mm)	UVP in € zzgl. MwSt.
483292	orange	125	2	auf Anfrage
483290	weiß	125	2	auf Anfrage
483289	schwarz	125	2	auf Anfrage
483291	blau	125	3	auf Anfrage



POS-Display

DRY MARKER



Hesse- Art.-Nr.	Modell Herstellernr.	Ausführung	UVP in € zzgl. MwSt.
483182	Display 650130	<ul style="list-style-type: none"> • 20x Trockenmarker HDM • 5x Nachfüllset mit 10 Grafitminen HRD-G • 5x Nachfüllset mit 4 Grafitminen, 3x roten & 3x gelben Kreideminen HRD-GRY 	300,80



Tieflochmarker

HIDHM



Hesse- Art.-Nr.	Modell Herstellernr.	Markiertiefe (mm)	Spitzen ø (mm)	UVP in € zzgl. MwSt.
483185	schwarz 650310	20	2	4,60
483186	rot 650320	20	2	4,60



Schlagschnurgerät

CLP30



Hesse- Art.-Nr.	Modell Herstellernr.	Schlagschnur Maße	Gewicht (g)	UVP in € zzgl. MwSt.
483174	CLP30 652113	30 m / ø 1 mm	205	27,50



Trockenmarker

HDM



Hesse- Art.-Nr.	Modell Herstellernr.	Länge d. Mine (mm)	Stärke d. Mine (mm)	UVP in € zzgl. MwSt.
483179	rot 650100	125	3	11,70



Minen-Nachfüllset, 10-teilig

HRD



Hesse- Art.-Nr.	Modell Herstellernr.	Länge (mm)	Stärke (mm)	VE	UVP in € zzgl. MwSt.
483180	graphit (grau) GÄNGIG 650110	125	3	10	7,10
483187	4x grau / 3x rot / 3x gelb 650120	125	3	10	7,10
483181	rot 650150	125	3	10	7,10
483183	gelb 650160	125	3	10	7,10
483184	blau 650170	125	3	10	7,10
483279	grün 650180	125	3	10	7,10
483280	weiß 650190	125	3	10	7,10



Schlagschnurkreide

Farbpuder



Hesse- Art.-Nr.	Modell Herstellernr.	VE	Gewicht (g)	UVP in € zzgl. MwSt.
480380	rot 652433	Dolomit + Eisenoxid	360	7,90
480383	blau 652533	Dolomit + Ultramarin	360	7,90
480342	gelb 652333	Dolomit + Eisenoxid	360	7,90
480344	weiß 652233	Dolomit	360	7,90



Wasserwaage
MPL



Hesse- Art.-Nr.	Modell Herstellernr.	Länge (mm)	Anzahl d. Libellen	UVP in € zzgl. MwSt.
483218	MPL 401303	68	1	18,90
483189	MPL MAGNETIC 401313	68	1	24,80



Wasserwaage
HRX1020



Hesse- Art.-Nr.	Modell Herstellernr.	Länge (mm)	Anzahl d. Libellen	UVP in € zzgl. MwSt.
483148	HRX1020 R100	95	2	25,70



Wasserwaage
TVP



Hesse- Art.-Nr.	Modell Herstellernr.	Länge (mm)	Anzahl d. Libellen	UVP in € zzgl. MwSt.
483146	TVP 25 401803	250	2	15,30



GDS 40

Wasserwaage
GDS



Hesse- Art.-Nr.	Modell Herstellernr.	Länge (mm)	Anzahl d. Libellen	UVP in € zzgl. MwSt.
483219	GDS 40 401503	400	2	17,60
483220	GDS 60 401603	800	2	24,10



Wasserwaage
SM

Hesse- Art.-Nr.	Modell Herstellernr.	Länge (mm)	Anzahl d. Libellen	UVP in € zzgl. MwSt.
483223	SM 40 405841	400	2	22,30
483224	SM 60 405851	600	2	24,90
483225	SM 80 405861	800	2	27,70



SM 40



SM 60



SM 80

4





Schnellspannzwinge

QCX



QCX 30



Hesse- Art.-Nr.	Modell Herstellernr.	Spannweite (mm)	Öffnung (mm)	Gewicht (g)	UVP in € zzgl. MwSt.
483240	QCX 30 521303	300	75	800	38,30
483242	QCX 60 521603	600	75	1.050	46,10



Stemmeisen

HDC



Hesse- Art.-Nr.	Modell Herstellernr.	Länge (mm)	Klingenbreite (mm)	Gewicht (g)	UVP in € zzgl. MwSt.
483284	HDC 12 390633	265	12	320	32,30
483286	HDC 18 390653	265	18	320	32,80
483212	HDC 20 390263	265	20	390	32,50
483213	HDC 25 390273	265	25	420	33,20
483214	HDC 32 390283	265	32	470	33,90
483215	HDC 40 390293	265	40	510	36,20



Set Stemmeisen

HDC



Hesse- Art.-Nr.	Modell Herstellernr.	Ausführung	UVP in € zzgl. MwSt.
483293	Set HDC 390673	4x Stemmeisen in Kunststoff- holster: 12-18-25-32 mm	120,40



Brechstange

A 1500 SB



Hesse- Art.-Nr.	Modell Herstellernr.	Länge (mm)	Gewicht (g)	UVP in € zzgl. MwSt.
483170	A 1500 SB 841024	1500	3.200	364,60



Kuhfuß

H 480 B



Hesse- Art.-Nr.	Modell Herstellernr.	Länge (mm)	Gewicht (g)	UVP in € zzgl. MwSt.
480312	H 480 B 841020	480	500	48,90



Nageleisen

209/25"



Hesse- Art.-Nr.	Modell Herstellernr.	Länge (mm)	Gewicht (g)	UVP in € zzgl. MwSt.
480300	109 / 25" GÄNGIG 824115	640	1.800	127,10

Hultafors

Zimmermannshammer

TS 20

Hesse- Art.-Nr.	Modell Herstellernr.	Länge (mm)	Gewicht (g)	UVP in € zzgl. MwSt.
483257	TS 20 820008	345	800	43,40

Hultafors

Zimmermannshammer

KP 650

Hesse- Art.-Nr.	Modell Herstellernr.	Länge (mm)	Gewicht (g)	UVP in € zzgl. MwSt.
483258	KP 650 820066	362	800	40,10

Hultafors

Nageleisen

108

* auch im Display erhältlich

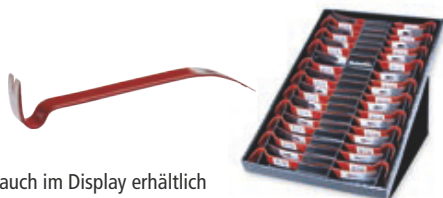

Hesse- Art.-Nr.	Modell Herstellernr.	Länge (mm)	Gewicht (g)	UVP in € zzgl. MwSt.
480299* GÄNGIG	108 / 7,5" 827023	190	77	8,70
483260	108 / 15" 827013	380	650	16,80

Hultafors

Nageleisen

409

Hesse- Art.-Nr.	Modell Herstellernr.	Länge (mm)	Gewicht (g)	UVP in € zzgl. MwSt.
480297	409 / 10" 824210	300	220	43,20

Hultafors

Kombihammer

T-Block

Hesse- Art.-Nr.	Modell Herstellernr.	Länge (mm)	Gewicht (g)	UVP in € zzgl. MwSt.
483272	C 250 S 821259	313	450	46,20
483273	C 375 M 821262	318	640	59,30
483274	C 600 L 821264	327	900	71,30

Hultafors

Elektriker Hammer

TR EL

Hesse- Art.-Nr.	Modell Herstellernr.	Grifflänge (mm)	Gewicht (g)	UVP in € zzgl. MwSt.
480367	TR EL 820050	295	620	97,60

Hultafors

Nageleisen

109

Hesse- Art.-Nr.	Modell Herstellernr.	Länge (mm)	Gewicht (g)	UVP in € zzgl. MwSt.
480296 GÄNGIG	109 / 12" 824009	300	450	58,20
480282 GÄNGIG	109 / 20" 824010	500	1.050	64,60
480283 GÄNGIG	109 / 25" 824011	625	1.450	77,60
480286 GÄNGIG	109 / 28" 824012	710	1.900	96,60
480284 GÄNGIG	109 / 36" 824013	910	2.500	129,20



Baueimer TB15



Baueimer TB15



Baueimer TB15 &
Organizer

Hesse- Art.-Nr.	Modell Herstellernr.	Ausführung	Gewicht (g)	UVP in € zzgl. MwSt.
483153 GÄNGIG	TB15 590101	Max. Traglast: 100 kg / Fassungsver- mögen: 15 l	930	18,50
483178 GÄNGIG	Organizer und Eimer 590101 & 490102	Anzahl der Fächer und Taschen: 31 Stück	1460	49,50



Werkzeugtasche Für Elektriker



Hesse- Art.-Nr.	Modell Herstellernr.	Ausführung	Maße (mm)	UVP in € zzgl. MwSt.
483299	Werkzeug- tasche 590180	21 Taschen und Werkzeughalter- ungen	310 x 150 x 390	69,60



Trittleiter Viking Step

Hesse- Art.-Nr.	Modell Herstellernr.	Anzahl d. Stufen	Maße (mm)	UVP in € zzgl. MwSt.
480345 GÄNGIG	Viking Step Mini 728141	2	480 x 415 x 507	164,90
480357	Viking Step Maxi 728143	3	720 x 571 x 672	240,40



Werkzeugtasche Für Elektriker



Hesse- Art.-Nr.	Modell Herstellernr.	Ausführung	Maße (mm)	UVP in € zzgl. MwSt.
483301	Werkzeug- tasche 590150	34 Taschen und Werkzeug- halterungen	340 x 310 x 470	88,80



Trolley-Werkzeugtasche Für Elektriker



Hesse- Art.-Nr.	Modell Herstellernr.	Ausführung	Maße (mm)	UVP in € zzgl. MwSt.
483307	Werkzeug- tasche 590170	33 Taschen und Werkzeughalter- ungen	380 x 330 x 430	155,10





4



Handwerkmesser

HVK



Hesse- Art.-Nr.	Modell Herstellernr.	Länge (mm)	Klingen- länge (mm)	Gewicht (g)	UVP in € zzgl. MwSt.
483141	HVK 380010	208	93	104	5,60



Handwerkmesser

HVK GH



Hesse- Art.-Nr.	Modell Herstellernr.	Länge (mm)	Klingen- länge (mm)	Gewicht (g)	UVP in € zzgl. MwSt.
483144	HVK GH 380210	208	93	109	8,50



Handwerkmesser

RFR GH



Hesse- Art.-Nr.	Modell Herstellernr.	Länge (mm)	Klingen- länge (mm)	Gewicht (g)	UVP in € zzgl. MwSt.
483143	RFR GH 380260	208	93	108	11,90



Sicherheitsmesser

SK



Hesse- Art.-Nr.	Modell Herstellernr.	Länge (mm)	Klingen- länge (mm)	Gewicht (g)	UVP in € zzgl. MwSt.
483165	SK 380080	203	88	102	5,60



Elektrikermesser im Köcher
ELK-L



Links-händer

Hesse- Art.-Nr.	Modell Herstellernr.	Länge (mm)	Klingen- länge (mm)	Gewicht (g)	UVP in € zzgl. MwSt.
483160	ELK-L 383030	158	33	90	6,40



Elektrikermesser im Köcher
ELK



Rechts-händer

Hesse- Art.-Nr.	Modell Herstellernr.	Länge (mm)	Klingen- länge (mm)	Gewicht (g)	UVP in € zzgl. MwSt.
483145	ELK 380030	158	33	90	6,40



Sanitärmesser
VVS



Hesse- Art.-Nr.	Modell Herstellernr.	Länge (mm)	Klingen- länge (mm)	Gewicht (g)	UVP in € zzgl. MwSt.
483164	VVS 380050	208	93	104	10,00



Sicherheitsmesser
SKR



Hesse- Art.-Nr.	Modell Herstellernr.	Länge (mm)	Klingen- länge (mm)	Gewicht (g)	UVP in € zzgl. MwSt.
483150	SKR 380030	203	88	102	7,90



Outdoormesser
OK4



Feuerstahl

Hesse- Art.-Nr.	Modell Herstellernr.	Länge (mm)	Klingen- länge (mm)	Gewicht (g)	UVP in € zzgl. MwSt.
483198	OK4 380270	208	93	120	24,50
483199	Feuerstahl 380280	100	-	60	12,00



Dämmstoffmesser
FGK



mit Schnitenschutz



Hesse- Art.-Nr.	Modell Herstellernr.	Länge (mm)	Klingen- länge (mm)	Gewicht (g)	UVP in € zzgl. MwSt.
480384	FGK 389010	465	316	228	17,80



Gipskartonsäge im Köcher
JS



Hesse- Art.-Nr.	Modell Herstellernr.	Länge (mm)	Blattlänge (mm)	Gewicht (g)	UVP in € zzgl. MwSt.
483147	JS 591260	260	130	136	17,70





Handsäge

HBX / BX-22-7

Hesse- Art.-Nr.	Modell Herstellernr.	Zähne pro Zoll	Blattstärke (mm)	Blattlänge (mm) (Zoll)	Gewicht (g)	UVP in € zzgl. MwSt.
483139	HBX-22-7 590703	7	130	520 22	580	36,60
483140	BX-22-7 590713	Sägeblatt zu Handsäge HBX			360	20,00



Mini-Axt

AGELSJÖN



Inkl.
Schneid-
schutz
(Hülle)

Hesse- Art.-Nr.	Modell Herstellernr.	Grifflänge (mm)	Gewicht (g)	UVP in € zzgl. MwSt.
480287	AGELSJÖN 841760	235	775	116,60

GÄNGIG



Zimmermanns-Axt

STALBERG



Inkl.
Schneid-
schutz
(Hülle)

Hesse- Art.-Nr.	Modell Herstellernr.	Grifflänge (mm)	Gewicht (g)	UVP in € zzgl. MwSt.
483264	STALBERG 841730	500	1.225	135,90





5

Tajima

Tajima

Cuttermesser



Tajima

Cutter

LC303 (lose)



Hesse- Art.-Nr.	Modell Herstellernr.	Ausführung	Länge (mm)	UVP in € zzgl. MwSt.
470072 <small>GÄNGIG</small>	LC520 9 mm	Taste / Kunststoff	130	3,80

Tajima

Cutter

DC360YB (SB)



Hesse- Art.-Nr.	Modell Herstellernr.	Ausführung	Länge (mm)	UVP in € zzgl. MwSt.
470375 <small>GÄNGIG</small>	DC360YB 9 mm	Taste / 2-K, Kunst- stoff gummiert	158	5,90

Tajima

Cutter

LC520 (lose)



Hesse- Art.-Nr.	Modell Herstellernr.	Ausführung	Länge (mm)	UVP in € zzgl. MwSt.
470096 <small>GÄNGIG</small>	LC520 18 mm	Taste / Kunststoff	160	6,90

Tajima

Sicherheitsmesser

VR103D (SB)



Hesse- Art.-Nr.	Modell Herstellernr.	Ausführung	Länge (mm)	UVP in € zzgl. MwSt.
470101 <small>GÄNGIG</small>	VR103D Trapez	3x Trapezklingen / Metall	165	16,30

Tajima

Cutter

LC500 (lose)

18 mm U



Hesse- Art.-Nr.	Modell Herstellernr.	Ausführung	Länge (mm)	UVP in € zzgl. MwSt.
470077 <small>GÄNGIG</small>	LC500 18 mm	Taste / Kunststoff	164	6,60

Tajima

Sortiment

LC500C40

18 mm U



Hesse- Art.-Nr.	Modell Herstellernr.	Ausführung	UVP in € zzgl. MwSt.
470080	LC500C40 18 mm	40x Cutter LC500 in 4 verschie- denen Farben im Theken-Display	260,70

Tajima

Cutter

LC521 (lose)

18 mm U



Hesse- Art.-Nr.	Modell Herstellernr.	Ausführung	Länge (mm)	UVP in € zzgl. MwSt.
470097 <small>GÄNGIG</small>	LC521 18 mm	Rädchen / Kunststoff	160	7,30

Tajima

Sicherheitscutter

LC650 (lose)

25 mm U



Hesse- Art.-Nr.	Modell Herstellernr.	Ausführung	Länge (mm)	UVP in € zzgl. MwSt.
470098 <small>GÄNGIG</small>	LC650 25 mm	Rädchen / Kunststoff	170	9,40

Tajima

Cutter

DC561YB (SB)

18 mm BK



Hesse- Art.-Nr.	Modell Herstellernr.	Ausführung	Länge (mm)	UVP in € zzgl. MwSt.
470111	DC561YB 18 mm	Rädchen / Kunststoff	168	9,50



Tajima

Sicherheitscutter

DC560YB (SB)

18 mm BK



Hesse- Art.-Nr.	Modell Herstellernr.	Ausführung	Länge (mm)	UVP in € zzgl. MwSt.
470376 <small>GÄNGIG</small>	DC560YB 18 mm	Taste / Kunststoff	168	9,50

Tajima

Sicherheitscutter

DFC569B (SB)

18 mm BK



Mit Quick-
Back™-
System

Hesse- Art.-Nr.	Modell Herstellernr.	Ausführung	Länge (mm)	UVP in € zzgl. MwSt.
470081	DFC569B 18 mm	Autom. Klingen- rückzug / Kunststoff	185	9,40

Tajima

Sortiment

Gürtelhalterset

18 mm BK SET



Hesse- Art.-Nr.	Modell Herstellernr.	Inhalt Sortiment	UVP in € zzgl. MwSt.
470114	Sortiment	2-teilig 1x Tajima Cutter DFC.569 B-SB 1x Tajima Holster DC50SFC/Y1	15,40

Tajima

Zugsäge

Pull 265 / Pull 265 R

Pull 265



Pull 265 R



Hesse- Art.-Nr.	Modell Herstellernr.	Klingenlänge (mm)	Gewicht (g)	UVP in € zzgl. MwSt.
470331	Pull 265 JPR265D	265	180	25,00
470332	Pull 265 R JPR265R-Y	600	230	35,00
470334	Ersatzblatt GNB250	250	56	11,20
470336	Ersatzblatt GNB265	265	76	11,70
470338	Ersatzblatt GNB300	300	100	12,50

Tajima

Schaber

SCR-C



Hesse- Art.-Nr.	Modell Herstellernr.	Klingenlänge (mm)	Gewicht (g)	UVP in € zzgl. MwSt.
470341	SCR-C50	50	191	20,00
470317	SCR-C75	75	219	20,00



Tajima

Klappsäge

Aluminist Power-Glide Fold



Hesse- Art.-Nr.	Modell Herstellernr.	Blattlänge (mm)	Blattstärke (mm)	UVP in € zzgl. MwSt.
470369	Aluminist ALOR240	240	3,0	53,50
470372	Aluminist ALOR300	300	3,0	59,20

Tajima

Schaber

SCR-M75



Hesse- Art.-Nr.	Modell Herstellernr.	Länge (mm)	Gewicht (g)	UVP in € zzgl. MwSt.
470325	SCR-M75	233	189	20,00

Tajima

Schaber

SCR-L



Hesse- Art.-Nr.	Modell Herstellernr.	Länge (mm)	Gewicht (g)	UVP in € zzgl. MwSt.
470326	SCR200	200	314	25,10
470327	SCR300	300	380	26,90
470337	SCR600	600	558	32,90

Tajima

Kartuschenpresse
Convoy Just



Übersetzung 7:1

Hesse- Art.-Nr.	Modell Herstellernr.	Kapazität (ml)	Länge (mm)	UVP in € zzgl. MwSt.
470323	CNV-JUST	310	372	18,00

GÄNGIG

Tajima

Kartuschenpresse
CNV100SP12-R1



Übersetzung 12:1

Hesse- Art.-Nr.	Modell Herstellernr.	Kapazität (ml)	Länge (mm)	UVP in € zzgl. MwSt.
470324	CNV100SP12	310	390	27,30

GÄNGIG

Tajima

Kartuschenpresse
CNV100SP26



Übersetzung 26:1

Hesse- Art.-Nr.	Modell Herstellernr.	Kapazität (ml)	Länge (mm)	UVP in € zzgl. MwSt.
470347	CNV-100SP26	310	385	40,80

Tajima

Kartuschenpresse
CNV2WAY



Übersetzung 12:1

Hesse- Art.-Nr.	Modell Herstellernr.	Kapazität (ml)	Länge (mm)	UVP in € zzgl. MwSt.
470345	CNV2WAY	300	530	70,10

600 ml Beutel

Tajima

Senklot
PZB



PZB400GD

PZB400D

PZB300D

Hesse- Art.-Nr.	Modell Herstellernr.	Maße Lotschnur	UVP in € zzgl. MwSt.
470322	PZB300D	0,9 mm x 3 m	29,10
470329	PZB400D	1,2 mm x 4,5 m	35,60
470346	PZB400GD	1,2 mm x 4,5 m	50,60

Tajima

Schlagschnurgerät
CR401SD SB



Hesse- Art.-Nr.	Modell Herstellernr.	Maße Schlagschnur	UVP in € zzgl. MwSt.
470320	CR401S/D1	Länge: 30 m / Ø 1 mm	36,70



Tajima

Bandmaß

Top Conve



Hesse- Art.-Nr.	Modell Herstellernr.	Bandlänge	Bandbreite (mm)	UVP in € zzgl. MwSt.
470260 <small>GÄNGIG</small>	TOP20MY	2	13	6,20
470262 <small>GÄNGIG</small>	TOP30MY	3	13	7,80
470264	TOP35MY	3,5	13	8,70
470268 <small>GÄNGIG</small>	TOP50MY	5	13	11,20

Tajima

Bandmaß

G-Lock



Hesse- Art.-Nr.	Modell Herstellernr.	Bandlänge	Bandbreite (mm)	UVP in € zzgl. MwSt.
470272	G6P30MY	3	16	14,20
470273 <small>GÄNGIG</small>	G5P50MYD	5	25	19,60
470275	G5P70MYD	7	25	24,80
470274	G5PA0MY	10	25	35,00



Tajima

Bandmaß

HI-Lock



Hesse- Art.-Nr.	Modell Herstellernr.	Bandlänge	Bandbreite (mm)	UVP in € zzgl. MwSt.
470234	H6P30MY	3	16	8,00
470238 <small>GÄNGIG</small>	H5P50MYD	5	25	14,70
470242	H5P70MYD	7	25	18,10
470243	H5PA0MY	10	25	22,10

Tajima

Bandmaß, selbstklebend

PIT



Hesse- Art.-Nr.	Modell Herstellernr.	Bandlänge	Bandbreite (mm)	UVP in € zzgl. MwSt.
470265	PIT10MW	1	13	6,50
470279	PIT20MW	2	13	10,10
470281 <small>GÄNGIG</small>	PIT30FR-EUR	3	13	11,80
470278 <small>GÄNGIG</small>	PIT50MW	5	13	15,80

Tajima

Messwinkel

Slant 200



Hesse- Art.-Nr.	Modell Herstellernr.	Maße (L x B x H) in mm	UVP in € zzgl. MwSt.
470283 <small>GÄNGIG</small>	SLT200my	256 x 123 x 22	71,50



LUTZ BLADES[®]

exactly

LUTZ EXPERIENCE[®]

Die universelle Klinge

U



LUTZ LONGLIFE[®]

Die harte Klinge

TiN

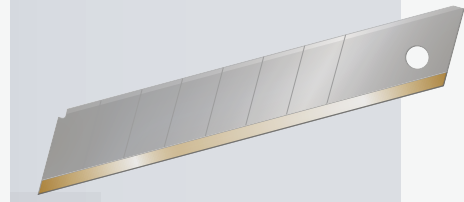

LUTZ MULTISHARP[®]

Die schwarze Klinge

BK

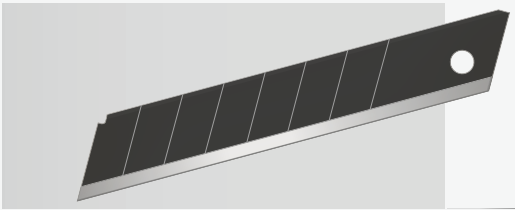

LUTZ HIGH PERFORMANCE

Die Hochleistungs-Klinge

BK TiN

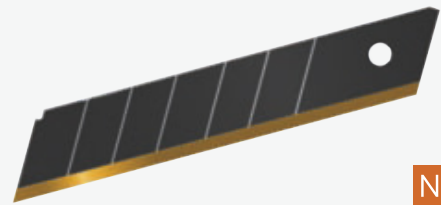

NEU

Schärfe der Klingen

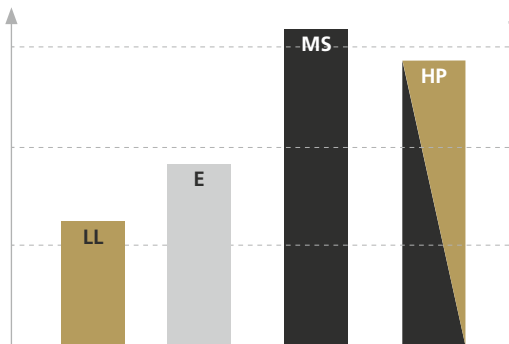

- LUTZ EXPERIENCE[®]**
Die universelle Klinge
- LUTZ LONGLIFE[®]**
Die harte Klinge
- LUTZ MULTISHARP[®]**
Die schwarze Klinge
- HIGH PERFORMANCE**
Die Hochleistungs-Klinge

DIE PERFEKTE LÖSUNG FÜR BESONDERE SCHNEIDHERAUSFORDERUNGEN

HIGH PERFORMANCE – die Hochleistungs-klinge by LUTZ BLADES vereint die besonderen Eigenschaften der LONGLIFE- und der MULTISHARP-Klinge: Durch eine einzigartige Zusammensetzung aus Materialauswahl, der bewährten Titanhärtung der Schneide und dem speziellen Schliffwinkel entsteht ein außergewöhnliches Schneidwerkzeug, welches bewusst auf extra Schärfe und Langlebigkeit ausgelegt wurde – zu Ihrem Nutzen, für Ihren Erfolg.

LUTZ Verpackungen:

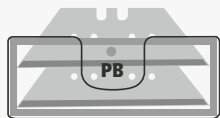

Pull Box

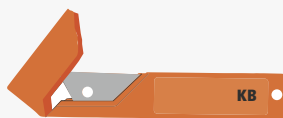

Klapp Box



Flip Box



Lutz Pack

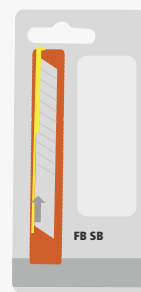

Flip Box auf SB-Karte

LUTZ BLADES[®]
exactly

Industrieklingen Abbrechklinge

9 mm



Hesse-Art.-Nr.	480597 <small>GÄNGIG</small>	480569	480588	470035	480584 <small>GÄNGIG</small>	480651 <small>GÄNGIG</small>	470069 <small>NEU</small>
Modell	AB10-KB 9 mm	AB10-FB SB 9 mm	AB10-KB 9 mm	AB102-FB SB 9 mm	AB10-FB SB 9 mm	AB10-FB 9 mm	AB102-FB SB 9 mm
Qualität	LUTZ EXPERIENCE [®]	LUTZ EXPERIENCE [®]	LUTZ EXPERIENCE [®]	LUTZ MULTISHARP [®]	LUTZ LONGLIFE [®]	LUTZ LONGLIFE [®]	HIGH PERFORMANCE
Verpackung							
Maße	Breite: 9 mm Länge: 80 mm Klingenstärke: 0,4 mm						
Segmente	12						
VE	10	10	100	10	10	10	10
UVP in € zzgl. MwSt.	3,30	4,50	29,60	5,70	5,10	7,90	7,20

LUTZ BLADES[®]
exactly

Industrieklingen Abbrechklinge

9 mm

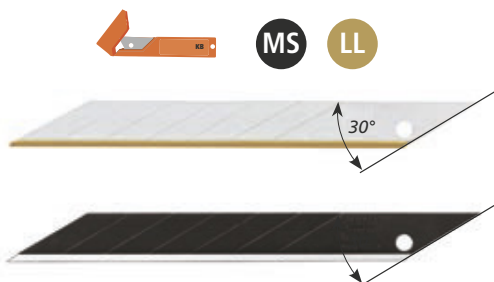

10x 9 mm-Abbrechklinge mit LUTZ LONGLIFE[®] Beschichtung in 30° geschliffen.

Hesse-Art.-Nr.	Modell	Qualität	Maße (mm)	VE	UVP in € zzgl. MwSt.
470032	AB10-KB 9 mm / 30°	LUTZ LONGLIFE [®]	9 x 80 x 0,4	10	5,80
470038	AB10-KB 9 mm / 30°	MULTISHARP [®]	9 x 80 x 0,4	10	6,20

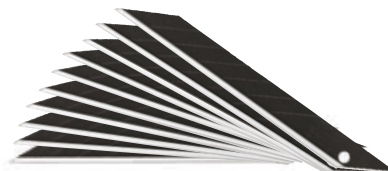

10x 9 mm-Abbrechklinge mit LUTZ MULTISHARP[®] Beschichtung in 30° geschliffen.

Industrieklingen
Abbrechklinge

18 mm



Hesse-Art.-Nr.	480596 GÄNGIG	480568 GÄNGIG	480589	470045 GÄNGIG	480573 GÄNGIG	480650	470146 NEU
Modell	AB2-KB 18 mm	AB2-FB SB 18 mm	AB2-KB 18 mm	AB22-FB SB 18 mm	AB2-FB SB 18 mm	AB2-FB 18 mm	AB22-FB SB 18 mm
Qualität	LUTZ EXPERIENCE [®]	LUTZ EXPERIENCE [®]	LUTZ EXPERIENCE [®]	LUTZ MULTISHARP [®]	LUTZ LONGLIFE [®]	LUTZ LONGLIFE [®]	HIGH PERFORMANCE
Verpackung							
Maße	Breite: 18 mm Länge: 100 mm Klingenstärke: 0,5 mm						
Segmente	12						
VE	10	10	100	10	10	10	10
UVP in € zzgl. MwSt.	4,00	4,70	37,40	5,70	7,90	13,10	9,60

Industrieklingen
**Sicherheits-
spender**

18 mm



Hesse-Art.-Nr.	470034 GÄNGIG	470041 GÄNGIG	470026	470044
Modell	AB2-SZ 18 mm im Sicherheitsspender	AB2-SZ 18 mm im Sicherheitsspender	AB22-SZ 18 mm im Sicherheitsspender	SZ-Sammelbox
Qualität	LUTZ EXPERIENCE [®]	LUTZ LONGLIFE [®]	LUTZ MULTISHARP [®]	-
Maße	120 x 55 x 25	120 x 55 x 25	120 x 55 x 25	120 x 65 x 25
Segmente	7	7	7	-
VE	50	50	50	1
UVP in € zzgl. MwSt.	18,50	31,90	26,40	11,60

5

Industrieklingen
Messer Klinge

Ohne Segmentierung

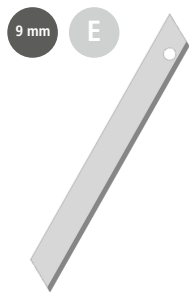

Hesse-Art.-Nr.	480621	480572	480594	480578
Modell	AB10-KB 9 mm	AB10-FB 9 mm	AB2-LP 18 mm	AB2-FB, 18 mm
Qualität	LUTZ EXPERIENCE [®]	LUTZ LONGLIFE [®]	LUTZ EXPERIENCE [®]	LUTZ LONGLIFE [®]
Verpackung				
Maße	Breite: 9 mm Länge: 80 mm Klingenstärke: 0,4 mm		Breite: 18 mm Länge: 100 mm Klingenstärke: 0,5 mm	
VE	10	10	10	10
UVP in € zzgl. MwSt.	4,20	9,10	6,50	14,50

Industrieklingen
Wellenschliffklinge

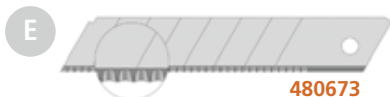

480673



480678

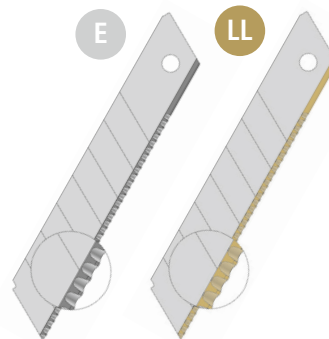

Hesse-Art.-Nr.	Modell	Qualität	Maße (mm)	VE	UVP in € zzgl. MwSt.
480673	AB26-LP 18 mm	LUTZ EXPERIENCE [®]	18 x 100 x 0,5	10	12,60
480678	AB26-LP 18 mm	LUTZ LONGLIFE [®]	18 x 100 x 0,5	10	15,20

Industrieklingen
Abbrechklinge



0,65 mm
Klingen-
stärke

Hesse-Art.-Nr.	Modell	Qualität	Maße (mm)	VE	UVP in € zzgl. MwSt.
480579	AB2-FB 18 mm	LUTZ LONGLIFE [®]	18 x 100 x 0,65	10	8,00

Industrieklingen
Abbrechhakenklinge



Hesse-Art.-Nr.	Modell	Qualität	Maße (mm)	VE	UVP in € zzgl. MwSt.
480593	AB5-FB 18 mm	LUTZ LONGLIFE [®]	18 x 104,5 x 0,5	10	13,20

Industrieklingen
Abbrechklinge



22 mm

E

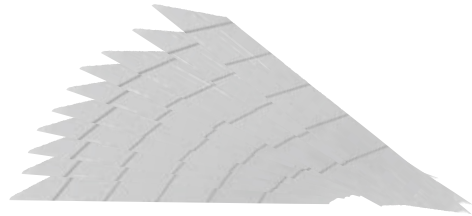

Hesse-Art.-Nr.	Modell	Qualität	Maße (mm)	VE	UVP in € zzgl. MwSt.
480659	AB9-LP 22 mm	LUTZ EXPERIENCE [®]	22 x 100 x 0,7	10	7,70

Industrieklingen
Abbrechklinge

25 mm

E



LL



MS



Hesse-Art.-Nr.	480668	480665	480677
Modell	AB8-LP 25 mm	AB8-LP 25 mm	AB82-LP 25 mm
Qualität	LUTZ EXPERIENCE [®]	LUTZ LONGLIFE [®]	LUTZ MULTISHARP
Verpackung			
Maße	Breite: 25 mm Länge: 125 mm Klingenstärke: 0,7 mm		
Segmente	7		
VE	10	10	100
UVP in € zzgl. MwSt.	12,00	15,20	13,40

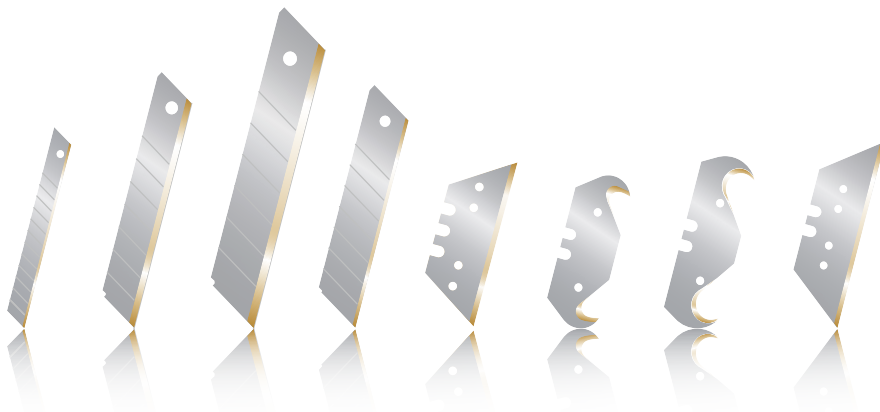

Industrieklingen
Trapezklingen



Hesse-Art.-Nr.	480583 <small>BÄNGIG</small>	480598 <small>BÄNGIG</small>	480570 <small>BÄNGIG</small>	470029
Modell	TGL65-FB/SB 18,7 mm	TGL65-PB 18,7 mm	TGL65-PB 18,7 mm	TGL652-PB 18,7 mm
Qualität	LUZ EXPERIENCE [®]	LUZ EXPERIENCE [®]	LUZ LONGLIFE [®]	LUZ MULTISHARP
Verpackung				
Maße	Breite: 18,7 mm Länge: 61 mm Klingenstärke: 0,65 mm			
VE	10	100	10	10
UVP in € zzgl. MwSt.	4,50	40,40	6,70	6,20

Industrieklingen
Trapezklingen



Hesse-Art.-Nr.	Modell	Qualität	Maße (mm)	Verpackung	VE	UVP in € zzgl. MwSt.
480599	TL65-FB SB 50,8 mm mit Mittelloch	LUZ EXPERIENCE [®]	18,7 x 50,8 x 0,65		10	4,00
480652	TL65-PB 50,8 mm mit Mittelloch	LUZ EXPERIENCE [®]	18,7 x 50,8 x 0,65		100	35,90

480652
10 x 10 Klingen (PB) =
1x VE zu 100 Klingen

5



Industrieklingen
TGL65-SZ im Spender

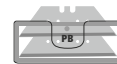

18 mm

E

Hesse-Art.-Nr.	Modell	Qualität	Maße (mm)	VE	UVP in € zzgl. MwSt.
480619	Trapezklingen im Sicherheitsspender, 18,7 mm	LUZ EXPERIENCE [®]	18,7 x 61 x 0,65	50	21,50

Industrieklingen

Hakentrapezklinge



Hesse- Art.-Nr.	Modell	Qualität	Maße (mm)	VE	UVP in € zzgl. MwSt.
480577	HT65 FB 18,7 mm	LUTZ EXPERIENCE [®]	18,7 x 50,7 x 0,65	10	13,10

Industrieklingen

Halbmondsichelklinge

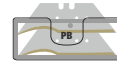

Hesse- Art.-Nr.	Modell	Qualität	Maße (mm)	VE	UVP in € zzgl. MwSt.
480638	HS65-PB 18,7 mm	LUTZ LONGLIFE [®]	18,7 x 58,9 x 0,65	10	9,10

Industrieklingen

Hakenklinge



Hesse- Art.-Nr.	480587 <small>GÄNGIG</small>	480600	480591	480580 <small>GÄNGIG</small>	470028
Modell	H65-PB, 18,7 mm, ohne Mittelloch	HL65-PB, 18,7 mm, mit Mittelloch	HL65-PB, 18,7 mm, mit Mittelloch	HL65-PB, 18,7 mm, mit Mittelloch	HL652-PB, 18,7 mm, mit Mittelloch
Qualität	LUTZ EXPERIENCE [®]	LUTZ EXPERIENCE [®]	LUTZ EXPERIENCE [®]	LUTZ LONGLIFE [®]	LUTZ MULTISHARP
Verpackung					
Maße	Breite: 18,7 mm Länge: 50,7 mm Klingenstärke: 0,65 mm		Breite: 18,7 mm Länge: 48,2 mm Klingenstärke: 0,65 mm		
VE	10	100	10	10	10
UVP in € zzgl. MwSt.	5,40	62,40	6,80	8,60	8,10

Industrieklingen

Hakenklinge



Hesse- Art.-Nr.	Modell	Qualität	Maße (mm)	Verpackung	VE	UVP in € zzgl. MwSt.
480601	HG65-PB 18,7 mm	LUTZ EXPERIENCE [®]	18,7 x 60 x 0,65		100	67,00
480590	HG65-PB 18,7 mm	LUTZ LONGLIFE [®]	18,7 x 60 x 0,65		10	8,90



480601



480590

Entgraterklinge



Hesse-Art.-Nr.	489616	489625 <small>GÄNGIG</small>	489618	489626
Modell	EGK6390-SZ	EGK6395-SZ	EGK7251-SZ	EGK6403-SZ
Herstellernr.	K36.50	K31.50	7251.0650	K31.40
Qualität	LUTZ EXPERIENCE [®]		LUTZ EXPERIENCE [®]	LUTZ EXPERIENCE [®]
Maße	Breite: 5,8 mm Länge: 33,3 mm Klingenstärke: 0,5 mm		57 x 11,1 x 0,65 mm	34,5 x 5,8 x 0,4 mm
VE	100	100	50	100
UVP in € zzgl. MwSt.	41,10	31,10	52,20	76,20

Skalpellklinge



Hesse-Art.-Nr.	470133	480631	480581 <small>GÄNGIG</small>
Modell	850-SZ, 11,1 mm	850-SZ, 11,1 mm	850-SZ, 11,1 mm
Qualität	LUTZ LONGLIFE [®]		
Maße	Breite: 11,1 mm Länge: 59,4 mm Klingenstärke: 0,65 mm		
VE	10	50	100
UVP in € zzgl. MwSt.	12,80	57,70	115,00

Folienklinge



Hesse-Art.-Nr.	Modell	Qualität	Maße (mm)	VE	UVP in € zzgl. MwSt.
480658	43.40 G-LP gerade	KARBON- STAHL	22 x 43 x 0,40	10	9,70

Universal Faltmesser 42653-10

Der Halter mit Clip kann mit allen handelsüblichen Trapez- und Hakenklingen in 0,65 mm Stärke mit 2 Kerben bestückt werden. Inkl. 10 Ersatzklingen (Hesse-Nr. 480570).



Ab 100 Stk.
mit indi-
vidueller
Gravur

Hesse-Art.-Nr.	Modell Herstellernr.	Material	Länge (mm)	UVP in € zzgl. MwSt.
490283	42653-10	Metall	110 (zu) 180 (offen)	16,90

Klingenhalter
KLHA 100

LL

Mit 1 TiN-
Klinge
bestückt



Hesse-Art.-Nr.	Modell Herstellernr.	Ausführung	Material	Länge (mm)	UVP in € zzgl. MwSt.
480637	KLHA 100	Taste	Kunststoff	155	8,90



9 mm Cutter

NT Cutter®

Cuttermesser
iA-300 RP

9 mm U



Hesse- Art.-Nr.	Modell Herstellernr.	Ausführung	Länge (mm)	UVP in € zzgl. MwSt.
489649	iA-300 RP 9 mm	Taste / Kunst- stoff	147	3,90

NT Cutter®

Cuttermesser
A-300 RP

9 mm U



Hesse- Art.-Nr.	Modell Herstellernr.	Ausführung	Länge (mm)	UVP in € zzgl. MwSt.
489660 <small>GÄNGIG</small>	A-300 RP 9 mm	Taste / Kunst- stoff	145	3,90

NT Cutter®

Cuttermesser
A-250 RP

9 mm U



Hesse- Art.-Nr.	Modell Herstellernr.	Ausführung	Länge (mm)	UVP in € zzgl. MwSt.
489559 <small>GÄNGIG</small>	A-250 RP 9 mm	Taste / Kunst- stoff	140	2,80

NT Cutter®

Cuttermesser
PMGA-EVO2

9 mm BK



Mit 30°-
Klinge
bestückt

Hesse- Art.-Nr.	Modell Herstellernr.	Ausführung	Länge (mm)	UVP in € zzgl. MwSt.
490013	PMGA-EVO2 9 mm/30°	Taste / Metall	160	9,30

NT Cutter®

Cuttermesser
AD-2P

9 mm U



Mit 30°-
Klinge
bestückt

Hesse- Art.-Nr.	Modell Herstellernr.	Ausführung	Länge (mm)	UVP in € zzgl. MwSt.
490149	AD-2P 9 mm/30°	Taste / Metall	135	7,70

NT Cutter®

Cuttermesser
A-300 GRP

9 mm U



Hesse- Art.-Nr.	Modell Herstellernr.	Ausführung	Länge (mm)	UVP in € zzgl. MwSt.
489642 <small>GÄNGIG</small>	A-300 GRP 9 mm	Taste / Metall	150	9,30

NT Cutter.

Cuttermesser

STL-ONE

9 mm U

Rostfrei



Hesse- Art.-Nr.	Modell Herstellernr.	Ausführung	Länge (mm)	UVP in € zzgl. MwSt.
489781	STL-ONE 9 mm	Taste / Metall	133	7,70

18 mm Cutter

NT Cutter.

Cuttermesser

L-500 P rot

18 mm U



Hesse- Art.-Nr.	Modell Herstellernr.	Ausführung	Länge (mm)	UVP in € zzgl. MwSt.
489942	L-500 P 18 mm	Rädchen / Kunststoff	162	8,00

NT Cutter.

Cuttermesser

L-500 GP

18 mm U



Hesse- Art.-Nr.	Modell Herstellernr.	Ausführung	Länge (mm)	UVP in € zzgl. MwSt.
489644	L-500 GP 18 mm	Rädchen / Metall	157	10,80

NT Cutter.

Cutter

PMGL-EVO2R

18 mm BK



Hesse- Art.-Nr.	Modell Herstellernr.	Ausführung	Länge (mm)	UVP in € zzgl. MwSt.
489691	PMGL-EVO2R 18 mm	Taste / Metall	160	16,60

NT Cutter.

Magazin-Cuttermesser

A-1000RP

Mit 2 Klingen bestückt

9 mm U



Hesse- Art.-Nr.	Modell Herstellernr.	Ausführung	Länge (mm)	UVP in € zzgl. MwSt.
490126	SA-400GRP 9 mm	Taste / Metall	185	10,30

NT Cutter.

Cuttermesser

L-500 GRP

18 mm U



Hesse- Art.-Nr.	Modell Herstellernr.	Ausführung	Länge (mm)	UVP in € zzgl. MwSt.
489643	L-500 GRP 18 mm	Taste / Metall	157	10,80

NT Cutter.

Magazin-Cuttermesser

L-2000 RP

Mit 2 Klingen bestückt

18 mm U



Hesse- Art.-Nr.	Modell Herstellernr.	Ausführung	Länge (mm)	UVP in € zzgl. MwSt.
489646	L-2000 RP 18 mm	Taste / Metall	135	29,70

NT Cutter.

Cuttermesser

PMGL-EVO2

18 mm BK



Hesse- Art.-Nr.	Modell Herstellernr.	Ausführung	Länge (mm)	UVP in € zzgl. MwSt.
490015	PMGL-EVO2 18 mm	Rädchen / Metall	158	16,60

NT Cutter.

Cuttermesser

L-300 RP blau



Hesse- Art.-Nr.	Modell Herstellernr.	Ausführung	Länge (mm)	UVP in € zzgl. MwSt.
489651 <small>GÄNGIG</small>	L-300 RP 18 mm	Taste / Kunst- stoff	156	4,40

NT Cutter.

Cuttermesser

L-300 RP rot



Hesse- Art.-Nr.	Modell Herstellernr.	Ausführung	Länge (mm)	UVP in € zzgl. MwSt.
489537 <small>GÄNGIG</small>	L-300 RP 18 mm	Taste / Kunst- stoff	156	4,40

NT Cutter.

Cuttermesser (Magazincutter)

L-700 RP



Mit 2 Klingen bestückt

Hesse- Art.-Nr.	Modell Herstellernr.	Ausführung	Länge (mm)	UVP in € zzgl. MwSt.
489647	L-700 RP 18 mm	Taste / Kunst- stoff	157	15,30

NT Cutter.

Sicherheitskartonöffner

R-1200



BR-400

R-1200

Mit 1x Ersatzklinge

Hesse- Art.-Nr.	Modell Herstellernr.	Länge (mm)	Gewicht	VE	UVP in € zzgl. MwSt.
489628	R-1200	193	122	1	17,50
489634 <small>GÄNGIG</small>	BR-400 Ersatzklinge	37 x 12 x 0,5	1,3	10	5,20

NT Cutter.

Kunststoff-Skalpell

D-400 P



BDC/200P 30°

D-400 P

Hesse- Art.-Nr.	Modell Herstellernr.	Länge (mm)	Gewicht (g)	VE	UVP in € zzgl. MwSt.
489671 <small>GÄNGIG</small>	D-400 P Inkl. 5 Ersatzklingen	132	20	1	5,20
470008	BDC/200P 30° Klinge	18	1,7	40	2,70
489675	BDA-200P 45° Klinge	21	1,7	40	2,70

NT Cutter.

Metall-Skalpell

D-500 GP / D-1000P



D-500 GP

D-1000 P

Hesse- Art.-Nr.	Modell Herstellernr.	Länge (mm)	Gewicht (g)	UVP in € zzgl. MwSt.
490150	D-500 GP	156	20	8,90
490279	D-1000 P	138	25	15,40

NT Cutter.

Schaber

QT-1 P

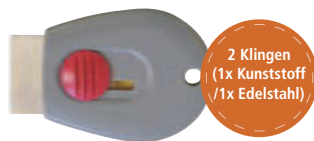

2 Klingen
(1x Kunststoff
/1x Edelstahl)

Hesse- Art.-Nr.	Modell Herstellernr.	Maße LxBxH (mm)	Gewicht	UVP in € zzgl. MwSt.
489689	QT-1 P	52 x 41 x 10	18	6,50

NT Cutter.

Cutter

Q-100 P



Hesse- Art.-Nr.	Modell Herstellernr.	Maße LxBxH (mm)	Gewicht (g)	UVP in € zzgl. MwSt.
490115	Q-100 P	64 x 37 x 10	10	2,40

NT Cutter

Cuttermesser

iL-120-40 blau



Hesse- Art.-Nr.	Modell Herstellernr.	Ausführung	UVP in € zzgl. MwSt.
489655	L-300RP-5 blau	Taste / Kunststoff	41,50

NT Cutter

Cuttermesser

iL-120-40 blau



Hesse- Art.-Nr.	Modell Herstellernr.	Ausführung	UVP in € zzgl. MwSt.
489654	iL-120-40 blau	Taste / Kunststoff	123,90

40 Stk. ergonomisch geformte Kunststoff-Cutter mit 18 mm-Abbrechklinge im Kunststoffeimer. Mit Drucktastenmechanik. Mit einer Klinge bestückt, ohne Ersatzklinge

NT Cutter

SCHABER

SC-2P



Hesse- Art.-Nr.	Modell Herstellernr.	Klingenbreite (mm)	UVP in € zzgl. MwSt.
489802	SC-2P	60	5,60

NT Cutter

Schneidunterlage

CM

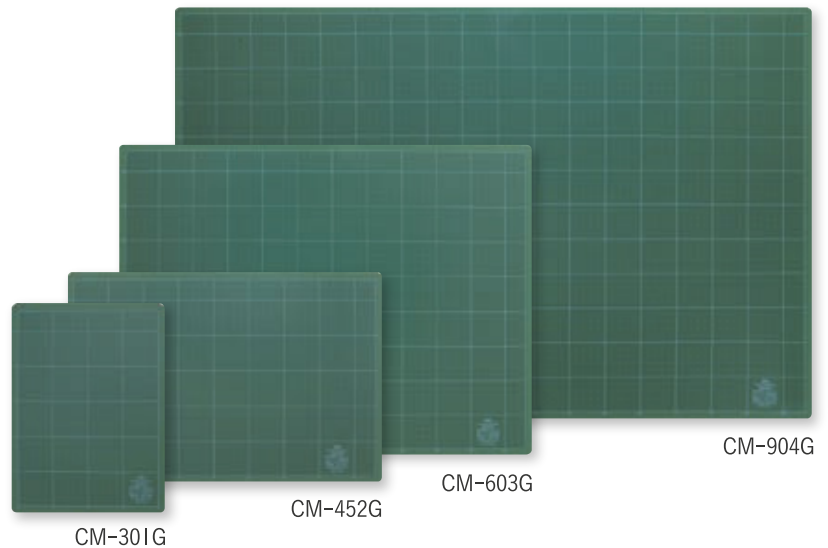

Hesse- Art.-Nr.	470016	470017	470018	470019
Modell	CM-301G	CM-452G	CM-603G	CM-904G
Material	PO-Kunstharz	PO-Kunstharz	PO-Kunstharz	PO-Kunstharz
Maße	300 x 220 x 3 mm	450 x 300 x 3 mm	600 x 450 x 3 mm	900 x 600 x 3 mm
VE	1	1	1	1
UVP in € zzgl. MwSt.	13,50	25,10	50,10	90,00



OLFA®

Cuttermesser

180 black

9 mm U



Hesse- Art.-Nr.	Modell Herstellernr.	Ausführung	Länge (mm)	UVP in € zzgl. MwSt.
489575	180 black 9 mm	Taste / Metall	138	6,40

OLFA®

Cuttermesser

L-1

18 mm U



Hesse- Art.-Nr.	Modell Herstellernr.	Ausführung	Länge (mm)	UVP in € zzgl. MwSt.
480566	L-1 18 mm	Rädchen / Kunststoff	150	12,70

OLFA®

Sicherheits-Folienschneider

SK-10

U



Hesse- Art.-Nr.	Modell Herstellernr.	Ausführung	Länge (mm)	UVP in € zzgl. MwSt.
480428	SK-10	Folienschneider / Kunststoff	159	16,80

OLFA®

Cuttermesser

SAC-1

9 mm Klinge INOX/30°



Hesse- Art.-Nr.	Modell Herstellernr.	Ausführung	Länge (mm)	UVP in € zzgl. MwSt.
489577	SAC-1 9 mm	Drucktaste / Ganzmetall	136	9,60

OLFA®

Cuttermesser

XL-2

18 mm U

Extra
lange
Klingen-
führung



Hesse- Art.-Nr.	Modell Herstellernr.	Ausführung	Länge (mm)	UVP in € zzgl. MwSt.
480417	XL-2 18 mm	Rädchen / Kunststoff	280	27,60

OLFA®

Skalpell

AK-1

U



Hesse- Art.-Nr.	Modell Herstellernr.	Ausführung	Länge (mm)	UVP in € zzgl. MwSt.
489580	AK-1	25 Ersatzklingen / Kunststoff	160	8,20
489600	KB Ersatzklingen (25 Stk. im Spender)			7,00

OLFA®

Cuttermesser mit schwarzer Klinge

A-5

9 mm



Hesse- Art.-Nr.	Modell Herstellernr.	Ausführung	Länge (mm)	UVP in € zzgl. MwSt.
480531	A-5 9 mm	Drucktaste / Kunststoff	146	7,30

OLFA®

Teppichschneider

45C



Hesse- Art.-Nr.	Modell Herstellernr.	Klingen- breite (mm)	Länge (mm)	Gewicht (g)	UVP in € zzgl. MwSt.
489581	45C	45	190	130	21,50
489603	RB-45-1 Ersatzklingen (VE = 1 Stk.)				7,90

OLFA®

Sicherheitsmesser

SK-4

U



Hesse- Art.-Nr.	Modell Herstellernr.	Ausführung	Länge (mm)	UVP in € zzgl. MwSt.
480506	SK-4	Selbsteinziehende Klinge / Kunststoff	140	14,50
489599	SKB Ersatzklingen (VE = 5 Stk. zu SK-4)			6,50

OLFA®

Mini-Automatikcutter

Touch-Knives® TK-4Y



Einweg &
Taschen-
format

U

Hesse- Art.-Nr.	Modell Herstellernr.	Ausführung	UVP in € zzgl. MwSt.
489663	TK-4Y 9535	Selbsteinziehende Klinge (Einweg) / Kunststoff	2,40

OLFA®

Cuttermesser mit schwarzer Klinge

Super L-175

18 mm



Hesse- Art.-Nr.	Modell Herstellernr.	Ausführung	Länge (mm)	UVP in € zzgl. MwSt.
489613	L-175 18 mm	Rädchen / Kunststoff	154	11,70

OLFA®

Rundscheider

RTY-2-DX



Hesse- Art.-Nr.	Modell Herstellernr.	Ausführung	VE	UVP in € zzgl. MwSt.
489582	RTY-2-DX	Ø 45 mm Klinge	1	29,00
489609	RB-45-1 (SB)	Passend zu RTY- 2-Serie & 45-C 10 Klingen	10	58,30



5

LEATHERMAN

Multitool
Micra®

10
Tools



Hesse- Art.-Nr.	Modell Herstellernr.	Maße LxBxH (mm)	Gewicht (g)	UVP in € zzgl. MwSt.
488605*	Micra® 640101-81N	64 x 19 x 0,9	50	50,00

*Ohne Holster

LEATHERMAN

Multitool
Skeletool, Silver

7
Tools



Hesse- Art.-Nr.	Modell Herstellernr.	Maße LxBxH (mm)	Gewicht (g)	UVP in € zzgl. MwSt.
488667*	Skeletool 830920	101 x 31 x 13	142	95,80

*Lieferung ohne Holster / passendes Zubehör: Holster M

LEATHERMAN

Multitool
Wingman®

14
Tools



Hesse- Art.-Nr.	Modell Herstellernr.	Maße LxBxH (mm)	Gewicht (g)	UVP in € zzgl. MwSt.
488944*	Wingman® 832523	96 x 32 x 16	194	94,10

ÖANGIG

*Lieferung ohne Holster / passendes Zubehör: Holster M

LEATHERMAN

Multitool
REBAR®

17
Tools



Hesse- Art.-Nr.	Modell Herstellernr.	Maße LxBxH (mm)	Gewicht (g)	UVP in € zzgl. MwSt.
488661*	REBAR® 831557	100 x 32 x 15	189	101,40

*Lieferung ohne Holster / passendes Zubehör: Holster M

LEATHERMAN

Multitool
Supertool® 300

19
Tools



Hesse- Art.-Nr.	Modell Herstellernr.	Maße LxBxH (mm)	Gewicht (g)	UVP in € zzgl. MwSt.
488644*	Supertool® 300 831148	113 x 36 x 19	286	136,40

*Lieferung ohne Holster / passendes Zubehör: Holster L

LEATHERMAN

Multitool
Wave®+

17
Tools



Hesse- Art.-Nr.	Modell Herstellernr.	Maße LxBxH (mm)	Gewicht (g)	UVP in € zzgl. MwSt.
488647*	Wave®+ 832524	98 x 36 x 16	243	151,40

*Lieferung ohne Holster / passendes Zubehör: Holster L

LEATHERMAN

Multitool

Signal

19
Tools



Hesse- Art.-Nr.	Modell Herstellernr.	Maße LxBxH (mm)	Gewicht (g)	UVP in € zzgl. MwSt.
488619*	Signal 832265	114 x 38 x 15	213	183,80

*Lieferung ohne Holster / passendes Zubehör: Holster L



LEATHERMAN

Multitool

Surge®

21
Tools



Hesse- Art.-Nr.	Modell Herstellernr.	Maße LxBxH (mm)	Gewicht (g)	UVP in € zzgl. MwSt.
488674*	Surge® 830165	112 x 40 x 19	335	181,80

*Lieferung ohne Holster / passendes Zubehör: Holster L

LEATHERMAN

Multitool

CHARGE+ TTI

19
Tools



Hesse- Art.-Nr.	Modell Herstellernr.	Maße LxBxH (mm)	Gewicht (g)	UVP in € zzgl. MwSt.
488664*	CHARGE+ TTI 832528	100 x 32 x 19	252	264,30

*Lieferung ohne Holster / passendes Zubehör: Holster M

LEATHERMAN

Multitool

Bit Kit inkl. 21 Bits

Bits
nach US-
Norm



Hesse- Art.-Nr.	Modell Herstellernr.	Ausführung	Gewicht (g)	UVP in € zzgl. MwSt.
488679	Bit Kit 931014	9x Sechskant, 2x Robertson, 1x Pozi, 3x Torx, 3x Kreuzschlitz, 3x Schlitz	84	33,50

LEATHERMAN

Multitool

Raptor® Rescue

6
Tools



Hesse- Art.-Nr.	Modell Herstellernr.	Maße LxBxH (mm)	Gewicht (g)	UVP in € zzgl. MwSt.
488943*	Raptor® Rescue 832167	127 x 31 x 18	164	123,10



LEATHERMAN

Holster



Hesse- Art.-Nr.	Modell Herstellernr.	UVP in € zzgl. MwSt.
488751	Holster M / 934928	17,20
488766	Holster L / 934929	17,20



VICTORINOX

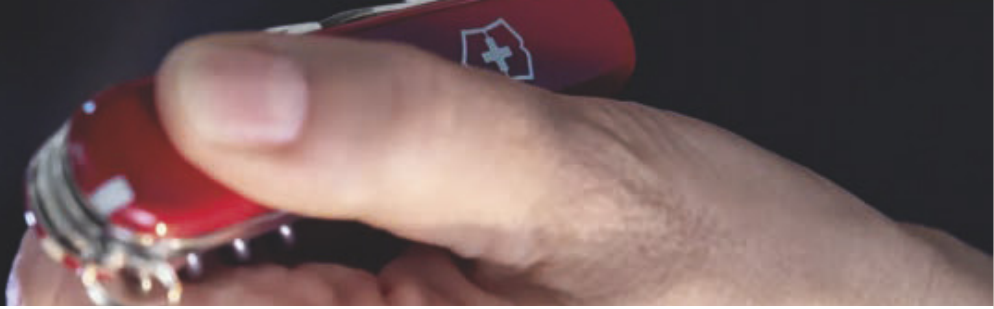

VICTORINOX
Taschenmesser
Spartan

11
Tools



Hesse- Art.-Nr.	Modell Herstellernr.	Maße LxBxH (mm)	Gewicht (g)	UVP in € zzgl. MwSt.
488808 <small>GÄNGIG</small>	Spartan 1.3603	91 x 26 x 14	59	26,10

VICTORINOX
Taschenmesser
Fieldmaster

14
Tools



Hesse- Art.-Nr.	Modell Herstellernr.	Maße LxBxH (mm)	Gewicht (g)	UVP in € zzgl. MwSt.
488841 <small>GÄNGIG</small>	Fieldmaster 1.4713	91 x 26 x 20	100	39,60
488843	Holster 4.0543	102 x 40 x 32	28	22,20

VICTORINOX
Taschenmesser
Picknicker

11
Tools



Hesse- Art.-Nr.	Modell Herstellernr.	Maße LxBxH (mm)	Gewicht (g)	UVP in € zzgl. MwSt.
488809 <small>GÄNGIG</small>	Picknicker 0.8353.3	111 x 32 x 16	103	43,40

VICTORINOX
Multitool
Manager

10
Tools



Hesse- Art.-Nr.	Modell Herstellernr.	Maße LxBxH (mm)	Gewicht (g)	UVP in € zzgl. MwSt.
488807	Manager 0.6366.T2	58 x 20 x 14	31	49,20

VICTORINOX
Multitool
CyberTool M

34
Tools



Hesse- Art.-Nr.	Modell Herstellernr.	Maße LxBxH (mm)	Gewicht (g)	UVP in € zzgl. MwSt.
488701	CyberTool M 1.7725.T	91 x 28 x 28	153	105,20





Bleimesser
4004

1
Tool



Hesse- Art.-Nr.	Modell Herstellernr.	Schneiden- länge (mm)	Länge (mm)	UVP in € zzgl. MwSt.
480602	4004-24-1LC	70	192	5,50



Kabelmesser
4001 CR

1
Tool



Hesse- Art.-Nr.	Modell Herstellernr.	Schneiden- länge (mm)	Länge (mm)	UVP in € zzgl. MwSt.
480605	4001 CR	86	202	6,10



Mit Klängen-
arretierung

Kabelmesser
4200/1 CRB

1
Tool



Hesse- Art.-Nr.	Modell Herstellernr.	Schneiden- länge (mm)	Länge (mm)	UVP in € zzgl. MwSt.
480636	4200/1 CRB	86	100	9,50



Kabelmesser
4008/2

2
Tools



Hesse- Art.-Nr.	Modell Herstellernr.	Schneiden- länge (mm)	Länge (mm)	UVP in € zzgl. MwSt.
480610	4008/2	74	163	14,30



Kabelmesser
4002/3

3
Tools



Hesse- Art.-Nr.	Modell Herstellernr.	Schneiden- länge (mm)	Länge (mm)	UVP in € zzgl. MwSt.
480615	4002/3	70	172	16,90



Kabelmesser
4002/4

4
Tools



Hesse- Art.-Nr.	Modell Herstellernr.	Schneiden- länge (mm)	Länge (mm)	UVP in € zzgl. MwSt.
480620	4002/4	78	179	20,70



Gurtbandmesser
4059/1A



Hesse- Art.-Nr.	Modell Herstellernr.	Schneiden- länge (mm)	Länge (mm)	UVP in € zzgl. MwSt.
480632	4059/1A	77	185	13,30



Ankermesser
2006/1



Hesse- Art.-Nr.	Modell Herstellernr.	Schneiden- länge (mm)	Länge (mm)	UVP in € zzgl. MwSt.
480667	2006/1	72	180	25,20



Taschenmesser
9811/N.A, INOX



Hesse- Art.-Nr.	Modell Herstellernr.	Schneiden- länge (mm)	Länge (mm)	UVP in € zzgl. MwSt.
480739 <small>NEU</small>	9811/N.A, INOX	66	165	12,80



Elektrikermesser
9901/N.A, INOX



Hesse- Art.-Nr.	Modell Herstellernr.	Schneiden- länge (mm)	Länge (mm)	UVP in € zzgl. MwSt.
480791 <small>NEU</small>	9901/N.A, INOX	84	200	14,60



Industriemesser
1096

480608



Hesse- Art.-Nr.	Modell Herstellernr.	Schneiden- länge (mm)	Länge (mm)	UVP in € zzgl. MwSt.
480608	Elektrikermesser 1096/19CR	82	192	7,80
480609	Elektrikermesser 224/Rot	82	192	7,80
480662 <small>GÄNGIG</small>	Arbeitsmesser 1096-ABB-MD, INOX	78	190	18,80
480666	Industriemesser 1096-20-5-LN, INOX	78	190	18,80
480675 <small>GÄNGIG</small>	Elektrikermesser 1096-20-2-K, INOX	79	191	18,80
480885	Arbeitsmesser 1096-ABB-MD, B/B	66	190	24,70
480697	Sicherheitsmesser 1096-SBB-RO, INOX	66	190	24,70

480609



480662



480666



480675



480885



480697



Mit Wellenschliff



Dämmstoffmesser
TRD0928

Hesse- Art.-Nr.	Modell Herstellernr.	Schneidenlänge (mm)	Länge (mm)	Gewicht (g)	UVP in € zzgl. MwSt.
480655 <small>NEU</small>	TRD0928	264	425	128	21,20





Industriemesser

1096

Hesse- Art.-Nr.	Modell Herstellernr.	Schneiden- länge (mm)	Länge (mm)	UVP in € zzgl. MwSt.
480797	Industriemesser H 1103015K	150	280	14,40
480798	Industriemesser H 1103118K	180	300	21,50
480801	Industriemesser H 11512077	250	380	31,70



480797



480798



480801



Cuttermesser

Mit schwarzer Klinge

18 mm

Hesse- Art.-Nr.	Modell Herstellernr.	Schneiden- länge (mm)	Länge (mm)	UVP in € zzgl. MwSt.
489658	2K-5017	100	175	5,30



ab 500 Stck. mit Logodruck



Sichheitsmesser

Diverse

Hesse- Art.-Nr.	Modell Herstellernr.	Breite der Klinge (mm)	Länge (mm)	Gewicht (g)	UVP in € zzgl. MwSt.
470009	8131-2 Mit 10 Ersatz- klingen	Trapezklinge	-	262	11,10
485838	8751-2 Mit 1 Ersatz- klinge	Trapezklinge	60	185	10,10
489791	Safety Cutter FD-798 Mit 10 Ersatz- klingen	Trapezklinge	160	149	6,80

Alle Cutter mit autom. Klingentrückzug



8131-2



8751-2



Safety Cutter FD-798



Messerhalter
mit Keramik Klinge

Keramik

Hesse- Art.-Nr.	Modell Herstellernr.	Klingen- stärke (mm)	Gewicht (g)	UVP in € zzgl. MwSt.
490278	Messerhalter	0,5	26	13,20



Kunststoff-
Fensterschaber

525000.0

Hesse- Art.-Nr.	Modell Herstellernr.	Klingen- breite (mm)	Gewicht (g)	UVP in € zzgl. MwSt.
480565	525000.0	60	39	2,30





Combischere INOX
4255 PL / 4273 PL



Hesse- Art.-Nr.	Modell Herstellernr.	Länge (mm)	Gewicht (g)	UVP in € zzgl. MwSt.
480671	4255 PL	150	68	14,30
GÄNGIG 480670	4273 PL rot	190	120	16,60
480676	4273 PL blau	190	120	16,60



4255



4273 orange



4273 blau



Kabelschere
4837 / 4839

Hesse- Art.-Nr.	Modell Herstellernr.	Ausführung	Länge (mm)	UVP in € zzgl. MwSt.
480672	4837	INOX-Schneide, Bis 10 mm ²	168	19,50
GÄNGIG 480685	4839 piccolo	INOX-Schneide, Bis 6 mm ²	134	17,80



Auch in
blau
erhältlich

4837

- max. 4 mm²
- max. 6 mm²
- max. 10 mm²

- max. 2,5 mm²
- max. 4 mm²
- max. 6 mm²

4839



Kabelschere
999 INOX



Hesse- Art.-Nr.	Modell Herstellernr.	Arbeitsbe- reich (mm ²)	Länge (mm)	UVP in € zzgl. MwSt.
480701	999 INOX rot	bis 6	140	9,40
480702	999 INOX blau	bis 6	140	9,40
480723	966 INOX rot	bis 6	140	13,50



Universalschere
No. 901 INOX



Hesse- Art.-Nr.	Modell Herstellernr.	Länge (mm)	Gewicht (g)	UVP in € zzgl. MwSt.
480694	901	210	240	43,20



Gewebescherer
Kevlar



Hesse- Art.-Nr.	Modell Herstellernr.	Länge (mm)	Gewicht (g)	UVP in € zzgl. MwSt.
480644	10,5" 229	265	152	98,00
480554	9,5" 229	240	139	71,60
480643	7" 337	160	60	62,70

265



240



160



Goldschmiedeschere
501 / 505



Hesse- Art.-Nr.	Modell Herstellernr.	Länge (mm)	Gewicht (g)	UVP in € zzgl. MwSt.
480695	501	173 gerade	88	11,60
480696	505 480695	172 gebogen	79	12,50



Papierscherer
200 mm / 8"



Hesse- Art.-Nr.	Modell Herstellernr.	Länge (mm)	Gewicht (g)	UVP in € zzgl. MwSt.
480691	200 mm / 8" P219N	200	71	17,40



Arbeitsscherer
4" - 10,5"



224-4



245-R-5



226-6

Hesse- Art.-Nr.	Modell Herstellernr.	Länge (mm)	Gewicht (g)	UVP in € zzgl. MwSt.
480532	110 mm / 4" 224-4	27	27	10,00
480537	135 mm / 5" 245-R-5	135	38	14,60
480716	155 mm / 6" 226-6	155	45	13,70
480715	195 mm / 7" 217-7	195	78	19,00
480552	215 mm / 8,5" 228-8,5	215	84	16,90
480720	240 mm / 9,5" 229-9,5	240	130	18,60
480719	265 mm / 10,5" 229-10,5	265	170	27,40

217-7



228-8,5



229-9,5



229-10,5





Taschenweberschere / Taschenschere

RD / SP

Hesse- Art.-Nr.	Modell Herstellernr.	Länge (mm)	UVP in € zzgl. MwSt.
480698	RD 189-4	110	12,50
480699	SP 189-4	110	9,40



480698

480699



129-8

129-10

129-12



Arbeitsschere, geschmiedet

8" - 12"



Stahl-
geschmie-
det

Hesse- Art.-Nr.	Modell Herstellernr.	Länge (mm)	Gewicht (g)	UVP in € zzgl. MwSt.
480679	210 mm / 8" 129-8	210	430	17,40
480681	255 mm / 10" GANIG 129-10	255	322	21,50
480683	310 mm / 12" 129-12	310	565	34,60

5



Arbeitsschere, leichte Modelle

6" / 10"



Patent

RING-LOCK
SYSTEM



6913-6"

6917-10"

Hesse- Art.-Nr.	Modell Herstellernr.	Länge (mm)	Gewicht (g)	UVP in € zzgl. MwSt.
480732	6913-6"	150	40	30,50
GANIG 480563	6917-10"	255	140	46,30



MS 200



MS 450



MS 600



HWC 9



NBC 600



CC 30

Hesse Art.-Nr.	Modell Herstellernr.	Produktbeschreibung	Gewicht (g)	UVP in € zzgl. MwSt.
498840	MS 200 200.10103	Stahlbandschere, geeignet zum Schneiden von Bandstahl, ausgestattet mit geschmiedetem Schneidkopf. Max. Schneidleistung: 32 x 0,9 mm	280	55,10
498839 GÄNGIG	MS 450 200.10039	Bandstahlschere, geeignet zum Schneiden von Bandstahl, ausgestattet mit geschmiedetem Schneidkopf. Max. Schneidleistung: 51 x 1,2 mm	1400	93,70
480523 GÄNGIG	MS 600 200.10034	Stahlbandschere, geeignet zum Schneiden von Bandstahl, ausgestattet mit geschmiedetem Schneidkopf. Max. Schneidleistung: 51 x 1,2 mm	2700	161,80
498836	HWC 9 200.10063	Drahtseilsehre zum Schneiden von Kupfer-, Aluminium-, Stahldraht und ACSR-Kabel. Ausgestattet mit Aluminiumgriffen. Max. Schneidleistung: 9 mm	1200	108,60
480527	NBC 600 200.10008	Bolzenschneider, ausgestattet mit schwarzem Kopf. Hergestellt aus geschmiedetem, legiertem Werkzeugstahl mit hoher Zugfestigkeit. Max. Schneidleistung: 8 mm	2800	82,50
498850	CC 30 200.10068	Die HIT Kabelsehre ist nur zum Schneiden von weichem Draht geeignet. Kupfer und Aluminium. Kein Stahlseil! Nur zum Arbeiten außerhalb spannungsführender Kabel! Max. Schneidleistung: 30 mm Durchmesser	3800	239,70





Metallsägebogen
No. 451 DIN



Hesse- Art.-Nr.	Modell Herstellernr.	Länge (mm)	Gewicht (g)	UVP in € zzgl. MwSt.
GÄNGIG 480543	No. 451	300	736	11,40



Handsägebogen
No. 200



Hesse- Art.-Nr.	Modell Herstellernr.	Länge (mm)	Gewicht (g)	UVP in € zzgl. MwSt.
480547	No. 200	400	690	20,30



Metallsägebogen
765 VDE



1000 V

Hesse- Art.-Nr.	Modell Herstellernr.	Länge (mm)	Gewicht (g)	UVP in € zzgl. MwSt.
461134	765 VDE	250	210	34,60
461144	767 VDE	450	600	45,90

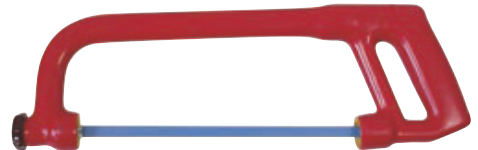

767 VDE



Sägebogen
305



Hesse- Art.-Nr.	Modell Herstellernr.	Stärke der Bügel (mm)	Gewicht (g)	UVP in € zzgl. MwSt.
GÄNGIG 480539	305-100	6,0	98	7,10



Universal Sägeblatt
306125



Hesse- Art.-Nr.	Modell Herstellernr.	Stärke der Bügel (mm)	Gewicht (g)	UVP in € zzgl. MwSt.
495310	306-125	6,0	126	6,50
480540	310-121 Ersatzbl.	6,0	42	7,40



Sägebogen
300



Hesse- Art.-Nr.	Modell Herstellernr.	Stärke der Bügel (mm)	Gewicht (g)	UVP in € zzgl. MwSt.
GÄNGIG 480534	300-110	5,4	120	12,40



Original Japan Zugsäge
PVC 300



Hesse- Art.-Nr.	Modell Herstellernr.	Länge (mm)	Gewicht (g)	UVP in € zzgl. MwSt.
490233	58031	450	145	42,30
490234	58032	300	74	17,20



Original Japansäge
Ryoba



Hesse- Art.-Nr.	Modell Herstellernr.	Länge (mm)	Gewicht (g)	UVP in € zzgl. MwSt.
470354	Ryoba	540	164	46,90
470356	Ersatzblatt	240	58	38,00

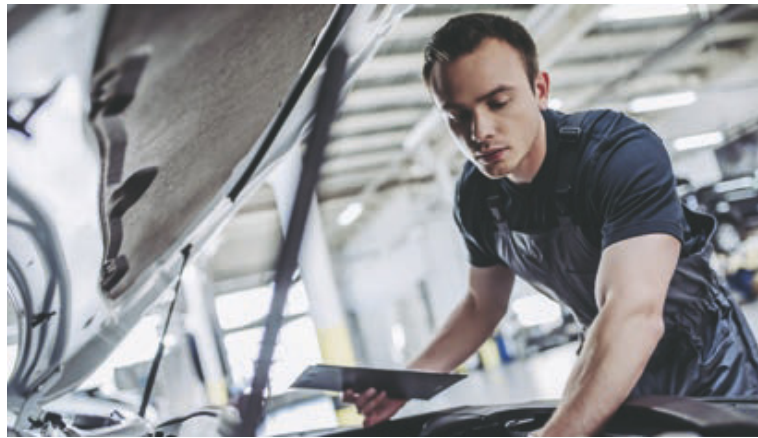



Koken

1/4" Steckschlüssel, lang
2300M



1/4"



RS2300M/12

Hesse- Art.-Nr.	Modell Herstellernr.	Größe (mm)	L (mm)	D2 (mm)	D1 (mm)	H1 (mm)	H2 (mm)	UVP in € zzgl. MwSt.
421161	2300M 6	6	50	11,2	9,2	7	40	6,20
421162	2300M 7	7	50	11,2	10,5	8	40	6,20
421163	2300M 8	8	50	11,2	11,8	9	40	6,20
421164	2300M 9	9	50	12,0	13,0	10	40	6,20
421171	2300M 10	10	50	12,9	14,3	11	39	6,30
421166	2300M 11	11	50	14,3	15,5	12	39	6,30
421165	2300M 12	12	50	15,5	16,8	13	39	6,50
421168	2300M 13	13	50	16,4	18,0	14	39	6,70
430490	RS2300M/12	Satz auf Halteschiene in den Gr.: 4, 5, 5.5, 6, 7, 8, 9, 10, 11, 12, 13, 14						71,70



2300M - 6 mm

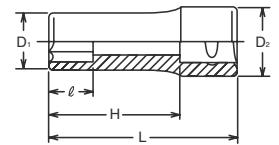

2233A	(1/4") X (3/8")		
3322A	(3/8") X (1/4")	Warranty/Garantia	86Nm
3344A	(3/8") X (1/2")		
4433A	(1/2") X (3/8")	Warranty/Garantia	290Nm
4466A	(1/2") X (3/4")		
6644A	(3/4") X (1/2")	Warranty/Garantia	668Nm

Koken

Adapter-Satz
PK2346/6

Hesse- Art.-Nr.	Modell Herstellernr.	Inhalt	UVP in € zzgl. MwSt.
422091	PK2346/6	2233A / 3344A / 4466A / 3322A / 4433A-35 / 6644A	64,70

Koken

Schraubendreher
mit Vierkantaufnahme
2769N / 3769N

Hesse- Art.-Nr.	Modell Herstellernr.	L (mm)	Antrieb	UVP in € zzgl. MwSt.
421321	2769N-150	150	1/4"	9,90
426563	3769N-160	160	3/8"	12,00



1/4"

2769N-150



3/8"

3769N-160

Koken

Steckschlüsselsätze auf Halteschienen

Sortimente

Hesse- Art.-Nr.	Modell Herstellernr.	Größe (mm)	Antrieb	UVP in € zzgl. MwSt.
430560	RS2010M/7-L25 Innensechskant	3, 4, 5, 6, 7, 8, 10	1/4"	33,50
430536	RS2025/7-L28(TH) Torx®	T10, T15, T20, T25, T27, T30, T40	1/4"	50,40
430574	RS2127/10 Impact Nut	4, 4.5, 5.5, 6, 7, 8, 9, 9.5, 10	1/4"	198,20
430550	RS2425/6 Torx®	E4, E5, E6, E7, E8 und E10	1/4"	20,40
426091	RS3025/8-L50 Torx®	T10, T15, T20, T25, T27, T30, T40, T45	3/8"	63,40
430633	RS3340M/8-L75	8, 10, 11, 12, 13, 14, 17, 19	3/8"	201,70
430485	RS3127/8	8, 9, 10, 11, 12, 13, 14, 16	3/8"	190,30
430622	RS4025/9-IP	20IP, 25IP, 27IP, 30IP, 40IP, 45IP, 50IP, 55IP, 60IP	1/2"	102,00
430841	RS4127/6	17, 19, 21, 22, 24, 25.4	1/2"	176,70
430625	RS4300M/10	10, 11, 12, 13, 14, 15, 17, 19, 21, 22	1/2"	101,80
425833	RS14012M/10-L60	4, 5, 6, 7, 8, 10, 12, 14, 17, 19	1/2"	156,80



RS2010M/7-L25 Innensechskant



RS2025/7-L28(TH) Torx® mit Loch



RS2127/10 Impact Nut Twister



Koken

Knarre verstellbar
Z-Serie

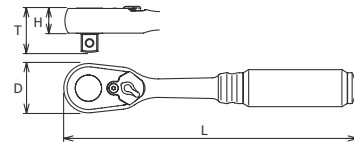

Hesse- Art.-Nr.	Modell Herstellernr.	D (mm)	T (mm)	H (mm)	L (mm)	Abtrieb	UVP in € zzgl. MwSt.
422019	2725Z	20,5	17,19	9,5	114	1/4"	59,60
421320	2726Z	20,5	17,1	9,5	114	1/4"	88,60
421784	3725Z	28,0	24,5	13,7	254	3/8"	63,60

Koken

1/2" Stehbolzenschrauber

4100M



Hesse- Art.-Nr.	Modell Herstellernr.	Größe (mm)	L (mm)	H (mm)	D (mm)	UVP in € zzgl. MwSt.
421660	4100M 6 mm	6	65	21	24	20,30
421661	4100M 7 mm	7	65	21	24	20,30
421662	4100M 8 mm	8	65	21	24	20,30
421663	4100M 9 mm	9	75	21	28	22,20
421664	4100M 10 mm	10	75	21	28	22,20
421666	4100M 11 mm	11	75	21	28	22,90
421667	4100M 12 mm	12	75	21	28	22,90

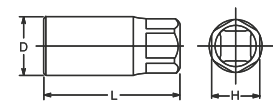

Koken

1/2"



1/2" Stehbolzenausdreher-Satz
4211M / 4214M

4211M

Hesse- Art.-Nr.	Modell Herstellernr.	Inhalt (mm / sw)	Antrieb	UVP in € zzgl. MwSt.
421675	4211M	6-8-10-12	1/2"	89,30
430829	4214M	6-8-10-12-14	1/2"	114,20

Koken

3/8"



Steckschlüssel
BD018

Hesse- Art.-Nr.	Modell Herstellernr.	L (mm)	D (mm)	Abtrieb	UVP in € zzgl. MwSt.
425142	BD018	45	31	3/8"	21,50

Koken

1/2"

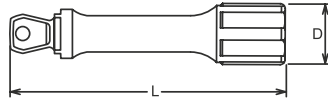

1/2" Winkelverlängerung
4760



Hesse- Art.-Nr.	Modell Herstellernr.	L (mm)	D (mm)	Abtrieb	UVP in € zzgl. MwSt.
422048	4760-400	400	24	1/2"	28,50
422047	4760-600	600	24	1/2"	36,30
422097	4760-900	900	24	1/2"	83,30
422078	4760-1000	1000	24	1/2"	83,30

Koken

1/2"



1/2" Winkelverlängerung
4763



Hesse- Art.-Nr.	Modell Herstellernr.	L (mm)	D (mm)	Abtrieb	UVP in € zzgl. MwSt.
422051	4763-50	50	24	1/2"	10,60
422076	4763-75	75	24	1/2"	12,00
422052	4763-125	125	24	1/2"	14,20
422053	4763-250	250	24	1/2"	21,00

Koken

1/2"

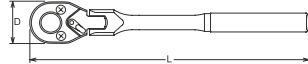

1/2" Gelenkknarre, verstellbar
4774JB



Hesse- Art.-Nr.	Modell Herstellernr.	L (mm)	D (mm)	Abtrieb	UVP in € zzgl. MwSt.
422072	4774JB	330	38	1/2"	82,30

Koken

1/2"

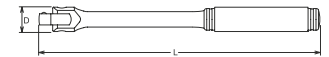

1/2" Gelenkgriff
4768J-380



Hesse- Art.-Nr.	Modell Herstellernr.	L (mm)	D (mm)	Abtrieb	UVP in € zzgl. MwSt.
422080	4768J-380	380	28	1/2"	39,70

Koken

1/2"



Set Winkelverlängerung
PK4763/5

Hesse- Art.-Nr.	Modell Herstellernr.	Inhalt	UVP in € zzgl. MwSt.
422082	PK4763/5	Verlängerungen in 50 / 75 / 125 / 150 / 250 mm	84,20

Koken

Schraubendrehersätze
auf Halteschienen
Sortimente



Hesse- Art.-Nr.	Modell Herstellernr.	Größe (mm)	Antrieb	UVP in € zzgl. MwSt.
430494	RS3129/6-L60	2, 3, 4, 6, 8, 10	3/8"	58,20
430843	RS4129/5-L75	8, 10, 12, 14, 16	1/2"	64,10

Koken

3/4" Stehbolzenschrauber
4100M



3/4"

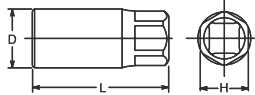

Hesse- Art.-Nr.	Modell Herstellernr.	Größe (mm)	L (mm)	H (mm)	D (mm)	UVP in € zzgl. MwSt.
432523	6100M 20 mm	20	100	36	48	148,90
432529	6100M 24 mm	24	100	36	48	170,80
432539	6100M 30 mm	30	125	46	63	224,40

Koken

3/4"

3/4" Knarre, verstellbar
6749-1000



Hesse- Art.-Nr.	Modell Herstellernr.	L (mm)	D (mm)	Abtrieb	UVP in € zzgl. MwSt.
433008	6749-1000	1000	68	3/4"	187,80

Koken

1"

1" L-Griff
8788



Hesse- Art.-Nr.	Modell Herstellernr.	L (mm)	Abtrieb	UVP in € zzgl. MwSt.
433061	8788	600	1"	110,40

Koken



1/4"

1/4" Bithalter für 1/4" Bits
2137

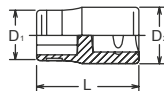

Hesse- Art.-Nr.	Modell Herstellernr.	L (mm)	D2 (mm)	D1 (mm)	UVP in € zzgl. MwSt.
421140	2137	22,5	12	12	5,80

Koken



3/8"

3/8" Bithalter für 1/4" Bits
3137/4137

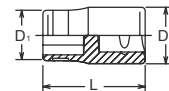

Hesse- Art.-Nr.	Modell Herstellernr.	L (mm)	D2 (mm)	D1 (mm)	UVP in € zzgl. MwSt.
426200	3137 3/8"	30	16,5	13	7,60
430806	4137 1/2"	38	22	13	7,60

Koken



3/8"

3/8" Bithalter für 5/16" Bits
3138

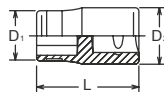

Hesse- Art.-Nr.	Modell Herstellernr.	L (mm)	D2 (mm)	D1 (mm)	UVP in € zzgl. MwSt.
426203	3138	38	18	16	7,80

Koken



3/8"

3/8" Impact-Bithalter
(Schnellwechselfutter)
13142

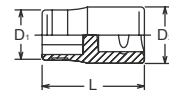

Hesse- Art.-Nr.	Modell Herstellernr.	L (mm)	D2 (mm)	D1 (mm)	UVP in € zzgl. MwSt.
441676	13142-F6.3 Bits 1/4" Form E 6,3	45	19	16,5	33,10
441678	13142-D6.3 Bits 1/4" Form C 6,3	45	19	16,5	31,00
441680	13142-F11.2 Bits 7/16" Form E 11,2	46	22	18,9	36,30

Koken

3/4"

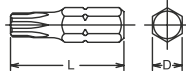

5/16" Schraubendrehereinsatz TORX
100T



Hesse- Art.-Nr.	Modell Herstellernr.	Größe	L (mm)	D (mm)	UVP in € zzgl. MwSt.
425236	100T-32 T20	T20	32	8	5,00
425239	100T-32 T25	T25	32	8	5,00
425245	100T-32 T30	T30	32	8	5,00
425248	100T-32 T40	T40	32	8	5,00
425246	100T-32 T45	T45	32	8	5,00
425250	100T-32 T50	T50	32	8	5,50
425249	100T-32 T55	T55	32	8	6,60

Koken



1/2"

1/2" Impact-Bithalter für 1/4" Bits
14139

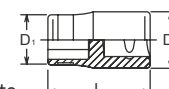

Hesse- Art.-Nr.	Modell Herstellernr.	L (mm)	D2 (mm)	D1 (mm)	UVP in € zzgl. MwSt.
441700	14139	35	25	11	13,20

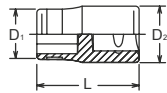
Koken**1/2"**1/2" Impact-Bithalter
(Schnellwechselfutter)**14142****14142-F6.3**

Hesse- Art.-Nr.	Modell Herstellernr.	L (mm)	D2 (mm)	D1 (mm)	UVP in € zzgl. MwSt.
441708	14142-D6.3 für 1/4" Bits / Form C 6,3	55	25	16	32,20
441706	14142-F6.3 für 1/4" Bits / Form E6.3	55	25	16,5	34,30
441711	14142-F11.2 für 7/16" Bits / Form E11.2	46	25	18,9	36,70

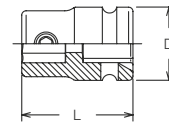
Koken**7/16"**Impact-Bithalter für
7/16" Bits**13134/14134**

Hesse- Art.-Nr.	Modell Herstellernr.	L (mm)	D (mm)	UVP in € zzgl. MwSt.
434444	13134 - 3/8" Vierkant für Bits 7/16" - Form E 11,2	32	22	13,20
441710	14134 - 1/2" für Bits 7/16" - Form E 11,2	38	25	14,60

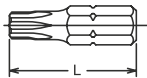
Koken**7/16"**Impact-Bits,
Innensechskant**183T****183T-35 T40**

7/16" Impact-Bits, TORX® DIN3126 Form E11.2

Hesse- Art.-Nr.	Modell Herstellernr.	Größe (mm)	L (mm)	UVP in € zzgl. MwSt.
422657	183T-35 T30	T30	35	6,80
422624	183T-35 T40	T40	35	6,80
422625	183T-35 T50	T50	35	7,00
422651	183T-35 T55	T55	35	7,00
422659	183T-75 T30	T30	75	7,50
422640	183T-75 T40	T40	75	7,50
422705	183T-75 T45	T45	75	7,50
422650	183T-75 T50	T50	75	7,50
422706	183T-75 T55	T55	75	7,50
422708	183T-150 T30	T30	150	12,00
422641	183T-150 T40	T40	150	12,00

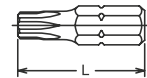
Koken**7/16"**Innensechskant
183H**183H-35 6 mm**

7/16" Impact Bit-Serie 183 nach DIN3126 E11.2/ ISO 1173 E11.2

Hesse- Art.-Nr.	Modell Herstellernr.	Größe (mm)	L (mm)	UVP in € zzgl. MwSt.
422674	183H-35 3mm	3	35	5,60
422702	183H-35 4mm	4	35	5,60
422649	183H-35 5mm	5	35	5,60
422654	183H-35 6mm	6	35	5,60
422658	183H-35 7mm	7	35	5,80
422637	183H-35 8mm	8	35	5,80
422715	183H-35 9mm	9	35	5,80
422655	183H-35 10mm	10	35	5,80
422671	183H-35 11mm	11	35	9,30
422636	183H-35 12mm	12	35	9,30
422712	183H-35 14mm	14	35	9,60
422656	183H-35 16mm	16	35	9,60
422703	183H-35 17mm	17	35	9,60
422699	183H-35 18mm	18	35	14,50
422652	183H-35 19mm	19	35	14,50

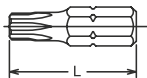
KokenImpact-Bits,
Innensechskant**107-16****107-16 12 mm**

Hesse- Art.-Nr.	Modell Herstellernr.	Größe (mm)	L (mm)	UVP in € zzgl. MwSt.
434003	107-16 12 mm	12	40	7,00
434006	107-16 14 mm	14	40	7,00
434009	107-16 17 mm	17	40	7,50
434012	107-16 19 mm	19	40	8,10
434015	107-16 22 mm	22	40	9,20

Koken

Impact-Bits, XZN

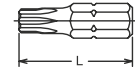
183X**7/16" / 6-kant**

Hesse- Art.-Nr.	Modell Herstellernr.	Größe	L (mm)	UVP in € zzgl. MwSt.
437507	183X-75 M10	M10	75	8,70
437513	183X-75 M12	M12	75	13,10

Koken

Impact-Bits,
Innensechskant
107-22

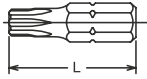

107-22 17 mm

Hesse- Art.-Nr.	Modell Herstellernr.	Größe (mm)	L (mm)	UVP in € zzgl. MwSt.
434031	107-22 17 mm	17	50	9,20
434030	107-22 19 mm	19	50	9,20
434033	107-22 22 mm	22	50	9,20
434036	107-22 24 mm	24	50	10,40
434039	107-22 27 mm	27	50	12,00

Koken

Impact-Bits,
TORX®
107T

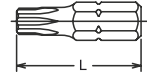

107-16T T60

Hesse- Art.-Nr.	Modell Herstellernr.	Größe (mm)	L (mm)	D2 (mm)	UVP in € zzgl. MwSt.
434026	107-16T T60	T60	50	16	11,00
434052	107-22T T90	T90	60	22	24,20
434048	107-22T T100	T100	60	22	24,40

Koken 1/2"

1/2" Impact
Stechschlüssel, lang
14300M

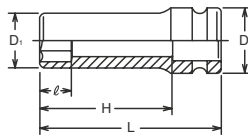

14300M 17 mm

Hesse- Art.-Nr.	Modell Herstellernr.	Größe (mm)	L (mm)	D2 (mm)	D1 (mm)	H1 (mm)	H2 (mm)	UVP in € zzgl. MwSt.
422867	14300M 17 mm	17	80	30	25.7	17	62	15,50
422869	14300M 19 mm	19	80	30	28.2	19	61	15,50
422874	14300M 24 mm	24	85	30	34.5	24	65	18,40
422879	14300M 30 mm	30	85	30	42	30	63	26,10
422880	14300M 32 mm	32	85	30	44.5	32	63	27,90
422881	14300M 36 mm	36	85	30	49.5	36	61	43,30

Koken 1/2"

1/2" Impact
Stechschlüssel
14400M

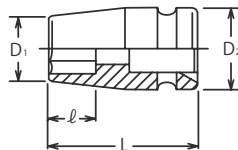

14400M 27 mm

Hesse- Art.-Nr.	Modell Herstellernr.	Größe (mm)	L (mm)	D2 (mm)	D1 (mm)	H (mm)	UVP in € zzgl. MwSt.
422919	14400M 17 mm	17	38	30	25.7	12	9,20
422920	14400M 18 mm	18	38	30	27	13	9,20
422921	14400M 19 mm	19	38	30	28.2	13	9,20
422923	14400M 21 mm	21	38	30	30.7	14	10,20
422924	14400M 22 mm	22	38	30	32	14	10,20
422926	14400M 24 mm	24	38	30	34.5	14	11,10
423102	14400M 27 mm	27	40	30	38.2	16	12,60
422932	14400M 30 mm	30	42	30	42	17	14,80
422933	14400M 32 mm	32	42	30	44.5	18	16,40
422937	14400M 36 mm	36	46	30	49.5	20	24,50
422942	14400M 41 mm	41	55	30	55.7	21	36,30

Koken



1/2"

Impact-Bits,
Surface Drive

14410M

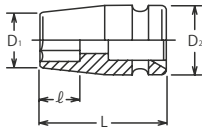

14410M 17 mm

Speziell für Schrauben mit abgerundeten Ecken. Die Schraube wird an den Flächen gegriffen.

Hesse- Art.-Nr.	Modell Herstellernr.	Größe (mm)	L (mm)	D2 (mm)	D1 (mm)	UVP in € zzgl. MwSt.
435859	14410M 13 mm	13	38	25	20.7	8,50
435871	14410M 17 mm	17	38	30	25.7	9,60
435874	14410M 19 mm	19	38	30	28.2	9,60

Koken



1/2"

Impact Bit-Steck-
schlüssel TORX®

14025-60



14025-60 T30

Hesse- Art.-Nr.	Modell Herstellernr.	Größe (mm)	L (mm)	UVP in € zzgl. MwSt.
435220	14025-60 T30	T30	60	15,90
435227	14025-60 T40	T40	60	15,90
435226	14025-60 T45	T45	60	15,90
435228	14025-60 T50	T50	60	16,60

*Biteinsatz nicht auswechselbar

Koken



1/2"

Impact
Gelenk-Einsatz

14440

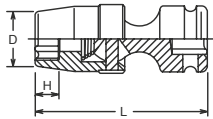

14410M 13 mm

Hesse- Art.-Nr.	Modell Herstellernr.	Größe (mm)	L (mm)	D (mm)	H (mm)	UVP in € zzgl. MwSt.
435946	14440M 17mm	17	69.5	25.7	8	37,30
435948	14440M 19mm	19	73.5	30.7	10	37,30
435950	14440M 21mm	21	73.5	30.7	11	37,30
435955	14440M 24mm	24	73.5	34.5	14	41,00

Koken



1/2"

Impact Steck-
schlüssel TORX®

14425E



14025-60 T30

Hesse- Art.-Nr.	Modell Herstellernr.	Größe (mm)	L (mm)	UVP in € zzgl. MwSt.
423450	14425 E10	E10	38	9,50
423451	14425 E12	E12	38	9,50
423452	14425 E14	E14	38	9,50
423453	14425 E16	E16	38	9,50
423454	14425 E18	E18	40	9,50
423455	14425 E20	E20	40	11,00
423458	14425 E22	E22	40	15,50
423456	14425 E24	E24	42	17,20

Koken



1/2"

Impact Schaftsteck-
schlüssel, mit Gelenk

14147M-150



Hesse- Art.-Nr.	Modell Herstellernr.	Größe (mm)	L (mm)	Antrieb	UVP in € zzgl. MwSt.
426710	14147M-150	10	150	1/2"	57,00

Koken



1/2"

Impact-Schaft-
steckschlüssel

14145PM



14145PM-110 17 mm

Koken



1/2"

Impact Schaftsteck-
schlüssel, mit Gelenk

14146M-150



Hesse- Art.-Nr.	Modell Herstellernr.	Größe (mm)	L (mm)	Antrieb	UVP in € zzgl. MwSt.
426667	14146M-150	17	150	1/2"	54,30

Koken



1/2"

Impact-Schaft-
steckschlüssel

14145PM

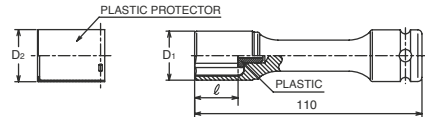

Hesse- Art.-Nr.	Modell Herstellernr.	Größe (mm)	L (mm)	UVP in € zzgl. MwSt.
441713	14145PM-110 17	17	110	24,90
441714	14145PM-110 19	19	110	24,90
441715	14145PM-110 21	21	110	26,30
441716	14145PM-110 22	22	110	28,50
441750	14145PM-110 17MB	17MB	110	32,20

Koken 1/2"

Impact Radmutter-
Steckschlüssel Satz
(3-teilig)

14201M



Hesse- Art.-Nr.	Modell Herstellernr.	Größe SW	UVP in € zzgl. MwSt.
435479	14201M	17 / 19 / 21	74,00



14208M
395 x 90 x 55 mm



14241M-00
196 x 100 x 45 mm



14245M-00
310 x 90 x 48 mm

Koken 1/2" auf 1/2"

Impact-Schnellwechsel-
adapter mit 1/2" Vierkant
Abtrieb

14444AL



Hesse- Art.-Nr.	Modell Herstellernr.	L (mm)	D2 (mm)	D1 (mm)	UVP in € zzgl. MwSt.
435954	14444AL	60	1/2"	1/2"	47,00

Koken 1/2" auf 3/4"

Impact-Verbindungs-
stück mit 3/4" Vierkant
Abtrieb

14466A



Hesse- Art.-Nr.	Modell Herstellernr.	L (mm)	D2 (mm)	D1 (mm)	UVP in € zzgl. MwSt.
422976	14466A	44	1/2"	3/4"	16,00



Koken 1/2"

Sortimente

Impact-Steckschlüssel Sätze

Hesse- Art.-Nr.	Modell Herstellernr.	Größe SW	UVP in € zzgl. MwSt.
435482	14208M	10/12/13/14/15/16/17/ 18/19/21/22/24/27	212,80
435486	14241M-00	13-teilig	125,30
435493	14245M-00	18-teilig	172,40
		+ Gelenk - 14770P + Verlängerung -14760 in 125 mm	

Koken 1/2"

Impact-Verlängerung,
mit Stift

14760



14760-125P

Nach DIN3121 Form E.

Hesse- Art.-Nr.	Modell Herstellernr.	L (mm)	UVP in € zzgl. MwSt.
423181	14760-125P	125	18,70
422980	14760-250P	250	22,80

Koken 1/2"

Impact-Gelenkstück, mit
Stiftloch, DIN3121 Form F

14771



Hesse- Art.-Nr.	Modell Herstellernr.	L (mm)	UVP in € zzgl. MwSt.
422989	14771 mit Stiftloch	65	36,00

Koken 1/2"

Impact-Gelenkstück,
mit Pin, DIN3121 Form E
14771-P



Hesse- Art.-Nr.	Modell Herstellernr.	L (mm)	UVP in € zzgl. MwSt.
422986	14771-P mit Pin	65	36,00

Koken 3/4"

Impact-Steckschlüssel
Torx®

16425 E24



Hesse- Art.-Nr.	Modell Herstellernr.	L (mm)	UVP in € zzgl. MwSt.
436555	16425 E24	50	26,40

Koken 3/4"

Impact-Steckschlüssel
Verlängerung

16760-175



Hesse- Art.-Nr.	Modell Herstellernr.	L (mm)	UVP in € zzgl. MwSt.
423403	16760-175	175	35,00

Koken 3/4"

Impact-
Steckschlüssel, kurz
16400M

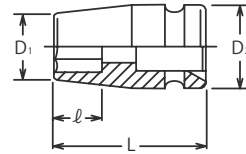

16400M 17 mm

Hesse- Art.-Nr.	Modell Herstellernr.	Größe (mm)	L (mm)	D2 (mm)	D1 (mm)	H (mm)	UVP in € zzgl. MwSt.
423370	16400M 17 mm	17	50	44	30	12	19,20
423371	16400M 18 mm	18	50	44	31.2	13	19,20
423372	16400M 19 mm	19	50	44	32.5	13	19,20
423374	16400M 22 mm	22	50	44	36.3	15	19,20
423376	16400M 24 mm	24	50	44	38.8	16	19,20
423379	16400M 27 mm	27	50	44	42.5	16	19,20
423382	16400M 30 mm	30	53	44	46.3	18	20,40
423384	16400M 32 mm	32	53	44	48.8	19	21,10
423386	16400M 34 mm	34	55	44	51.3	20	24,00
423388	16400M 36 mm	36	55	44	53.8	20	24,50
423390	16400M 38 mm	38	57	44	56.3	20	28,10
423411	16400M 39 mm	39	57	44	57.5	20	30,70
423391	16400M 41 mm	41	57	44	60.0	22	30,70
423394	16400M 46 mm	46	62	44	66.3	23	37,00
423396	16400M 50 mm	50	62	54	71.3	30	48,60
423399	16400M 55 mm	55	62	54	77.5	29	57,00
423369	16400M 60 mm	60	65	54	83.8	31	66,60

Koken 3/4" und 1"

Impact-Steckschlüssel
Extra lang für Radmuttern

16102M/18102M



16102M-270

Hesse- Art.-Nr.	Modell Herstellernr.	Größe (SW)	L (mm)	UVP in € zzgl. MwSt.
436256	16102M-270 30	3/4" 30	270	90,60
436259	16102M-270 32	3/4" 32	270	96,20
436268	16102M-400 32	3/4" 32	400	112,60
437052	18102M-270 32	1" 32	270	127,90
437058	18102M-270 36	1" 36	270	127,90
437106	18102M-400 32	1" 32	400	137,80

Koken 3/4" auf 1/2"

Impact-Verbindungsstück
auf 1/2" Vierkant

16644A/16644A-P



16644A-P

3/4" Impact-Verbindungsstück auf 1/2" Vierkant, DIN3121 Form F/E

Hesse- Art.-Nr.	Modell Herstellernr.	L (mm)	D1	D2	UVP in € zzgl. MwSt.
423173	16644A mit Stiftloch	52	1/2"	3/4"	26,30
423172	16644A-P mit Loch	52	1/2"	3/4"	26,30

Koken 3/4" auf 1"

Impact-Gelenkstück
16688A



Hesse- Art.-Nr.	Modell Herstellernr.	L (mm)	D1	D2	UVP in € zzgl. MwSt.
423402	16688A	62	1/2"	3/4"	30,00

Koken 3/4"

Impact-Gelenkstück
16770

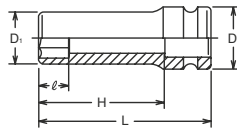

Hesse- Art.-Nr.	Modell Herstellernr.	L (mm)	UVP in € zzgl. MwSt.
423407	16770	106	66,30

Koken**3/4"**Impact-Steckschlüssel,
dünnwandig, lang**16301M****16301M 24 mm**

Hesse- Art.-Nr.	Modell Herstellernr.	Größe (mm)	L (mm)	D2 (mm)	D1 (mm)	H1 (mm)	H2 (mm)	UVP in € zzgl. MwSt.
436412	16301M 24 mm	24	100	43	36.8	24	74	32,40
436415	16301M 27 mm	27	100	43	40.5	27	73	32,40
436418	16301M 30 mm	30	100	43	44.3	30	73	33,70
436421	16301M 32 mm	32	100	43	46.8	32	72	34,30
436427	16301M 36 mm	36	100	43	51.8	36	71	41,30
436445	16301M 41 mm	41	100	43	58.0	38	69	48,00
436431	16301M 46 mm	46	100	43	64.3	38	68	62,30

Koken**1"**

Impact-Steckschlüssel, lang

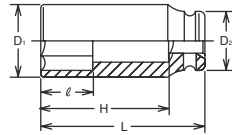
18300M**18300M 27 mm**

Hesse- Art.-Nr.	Modell Herstellernr.	Größe (mm)	L (mm)	D2 (mm)	D1 (mm)	H1 (mm)	H2 (mm)	UVP in € zzgl. MwSt.
437348	18300M 27 mm	27	108	54	45.3	27	77	51,60
437350	18300M 28 mm	28	108	54	46.5	28	77	51,60
437360	18300M 32 mm	32	108	54	51.5	32	77	51,60
437410	18300M 55 mm	55	108	66	80.3	63	-	96,20
437420	18300M 70 mm	70	108	66	99	55	-	124,60
437422	18300M 75 mm	75	108	86	105.3	52	-	150,20

Koken**1"**

Impact-Steckschlüssel

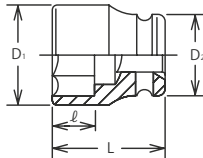
18400M**18300M 27 mm**

Hesse- Art.-Nr.	Modell Herstellernr.	Größe (mm)	L (mm)	D2 (mm)	D1 (mm)	H (mm)	UVP in € zzgl. MwSt.
439721	18400M 27 mm	27	57	54	45.3	16	32,20
439730	18400M 30 mm	30	62	54	49	21	32,20
439733	18400M 32 mm	32	62	54	51.5	21	32,20
439737	18400M 34 mm	34	62	54	54	21	32,20
439745	18400M 36 mm	36	62	54	56.5	21	32,90
439754	18400M 41 mm	41	66	54	62.8	25	42,00
439760	18400M 46 mm	46	70	54	69	29	43,70
439769	18400M 50 mm	50	70	66	74	35	58,00
439787	18400M 60 mm	60	75	66	86.5	39	76,00



Koken 1"

Impact-Innensechskant-Steckschlüssel

18107



18107-22 19 mm

Hesse- Art.-Nr.	Modell Herstellernr.	Größe (mm)	L (mm)	UVP in € zzgl. MwSt.
437213	18107-22 19 mm	19	98	46,50
437216	18107-22 22 mm	22	98	46,50
437219	18107-22 24 mm	24	98	47,60
437221	18107-22 27 mm	27	98	49,20

*Biteinsatz auswechselbar

Koken 1"-1/2"

Impact-Steckschlüssel

17400M



17400M 105

Hesse- Art.-Nr.	Modell Herstellernr.	Größe (mm)	L (mm)	UVP in € zzgl. MwSt.
423580	17400M 36	36	77	159,20
423521	17400M 80	80	110	336,30
423522	17400M 85	85	110	372,90
423523	17400M 90	90	112	392,90
423526	17400M 105	105	120	609,30
423528	17400M 115	115	128	759,10
423532	17400M 135	135	145	1.052,00

Koken 1/2" 3/4"

Stifte

Pin



A41 = 1401A

Hesse- Art.-Nr.	Modell Herstellernr.	L (mm)	UVP in € zzgl. MwSt.
422486	A41 = 1401A zu 1/2" bis SW ≤ 14 mm	20	0,70
422488	A42 = 1402A zu 1/2" ab SW > 14 mm	25	0,70
422524	A61 = 1601A zu 3/4" bis SW ≤ 46 mm	35	0,70
422515	A62 = 1602A zu 3/4" ab SW > 46 mm	45	0,80

Koken 1" 1/2" 3/4"

C-Ringe

C-Ring



Hesse- Art.-Nr.	Modell Herstellernr.	L (mm)	UVP in € zzgl. MwSt.
422490	C41 = 1401C zu 1/2" bis SW ≤ 14 mm	23	1,00
422491	C42 = 1402C zu 1/2" ab SW > 14 mm	26	1,00
422506	C61 = 1600C zu 3/4" bis SW ≤ 46 mm	41	1,80
422496	C81 = 1801C zu 1" ab SW > 70 mm	50	1,80

Koken 1" auf 3/4"

Impact-Reduzierstück

18866A



Hesse- Art.-Nr.	Modell Herstellernr.	L (mm)	D1	D2	UVP in € zzgl. MwSt.
423786	18866A	65	3/4"	1"	40,30

Koken 1 1/2"

Impact-Verlängerung

17760-250



Hesse- Art.-Nr.	Modell Herstellernr.	L (mm)	UVP in € zzgl. MwSt.
423543	17760-250	250	519,40

Koken 1 1/2" auf 1"

Impact-Reduzierstück

17788A



1" Vierkant mit Stiftloch für Sicherungsfeder

Hesse- Art.-Nr.	Modell Herstellernr.	L (mm)	D2	D1	UVP in € zzgl. MwSt.
423544	17788A	97	1-1/2"	1"	176,80

Koken 1/2" 3/4"

Ringe

O-Ring

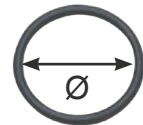

B41 = 1401B

Hesse- Art.-Nr.	Modell Herstellernr.	L (mm)	UVP in € zzgl. MwSt.
422487	B41 = 1401B zu 1/2" bis SW ≤ 14 mm	19	0,90
422489	B42 = 1402B zu 1/2" ab SW > 14 mm	24	0,90
422525	B61 = 1601B zu 3/4" bis SW ≤ 46 mm	36	1,30
422495	B81 = 1602B zu 3/4" ab SW > 46 mm	45	1,70

Koken 1" 1/2" 3/4"

C-Ringe (10-teilig)

C-Ring (Set)



Hesse- Art.-Nr.	Modell Herstellernr.	L (mm)	UVP in € zzgl. MwSt.
422602	PKC31 = PK 1301C zu 3/8" bis SW ≤ 12 mm	18	11,10
422508	PKC31 = PK 1401C zu 1/2" bis SW ≤ 14 mm	23	13,20
422503	PKC31 = PK 1402C zu 1/2" bis SW ≤ 14 mm	26	13,20
422504	PKC31 = PK 1600C zu 3/4" bis SW ≤ 46 mm	41	20,60
422597	PKC81 = PK 1801C zu 1" bis SW ≤ 70 mm	41	21,00

Koken 1/4"

Steckschlüssel mit 1/4" Sechskant-Schaft

BD014E



BD014E 10

Form E 6.3, für Akkuschrauber

Hesse- Art.-Nr.	Modell Herstellernr.	Größe (mm)	L (mm)	UVP in € zzgl. MwSt.
425108	BD014E 10	10	104	15,40
425120	BD014E 13	13	104	15,20
425138	BD014E 17	17	104	16,90
425123	BD014E 19	19	104	17,50

Koken 1/4"

Impact-Verbindungsstücke mit Außenvierkant mit Sicherungsstift

110-50P / 112-50P



110-50P

Form E 6.3, für Akkuschrauber

Hesse- Art.-Nr.	Modell Herstellernr.	L (mm)	UVP in € zzgl. MwSt.
434064	110-50P	50	7,70
434074	112-50P	50	8,60

Koken 1/4"

Impact-Steckschlüsselklingen

113-50E



113-50 8 mm

DIN3126 E6.3

Hesse- Art.-Nr.	Modell Herstellernr.	Größe Torx®	L (mm)	D2 (mm)	H (mm)	UVP in € zzgl. MwSt.
422434	113-50 E6	E6	50	8.3	5	10,10
422299	113-50 E8	E8	50	10.1	6.6	5,30

Koken 1/4"

Impact-Steckschlüsselklingen

115

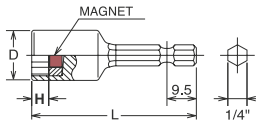

115-50 7

DIN3126 E6.3, mit Magnet

Hesse- Art.-Nr.	Modell Herstellernr.	Größe (SW)	L (mm)	Antrieb	UVP in € zzgl. MwSt.
422444	115-50 7	7	50	1/4"	3,70
422445	115-50 8	8	50	1/4"	3,70
422446	115-50 10	10	50	1/4"	4,10
422448	115-50 13	13	50	1/4"	6,60
422453	115-75 10	10	75	1/4"	14,60
422327	115-100 8	8	100	1/4"	17,30
422455	115-150 8	8	150	1/4"	19,30

Koken 1/4"

Impact-Verbindungsstücke mit Außenvierkant mit Kugel

110-B / 112-B / 135E-B



110-50B

Form E 6.3, für Akkuschrauber

Hesse- Art.-Nr.	Modell Herstellernr.	L (mm)	D1	UVP in € zzgl. MwSt.
434063	110-50B	50	1/4" H	7,70
434066	110-100B	100	1/4" H	8,10
434072	112-50B	50	3/8" H	8,60
434071	135E-60B	60	1/2" H	11,80

Koken 1/4"

Impact-Steckschlüsselklingen

113-50



113-50 8 mm

DIN3126 E6.3

Hesse- Art.-Nr.	Modell Herstellernr.	Größe	L (mm)	UVP in € zzgl. MwSt.
422433	113-50 8	8 mm	50	3,60
422313	113-50 10	10 mm	50	4,10
422301	113-50 3/8	3/8"	50	4,40

Koken 1/4"

Impact-Steckschlüsselklingen

113UN



113UN-100 8

DIN3126 E6.3, mit Gelenk

Hesse- Art.-Nr.	Modell Herstellernr.	Größe (SW)	L (mm)	UVP in € zzgl. MwSt.
422424	113UN-100 8	8	100	44,80
422425	113UN-100 10	10	100	44,80
422428	113UN-150 10	10	150	46,20
422429	113UN-150 12	12	150	46,20
422427	113UN-150 13	13	150	46,20

Koken 1/4"

Impact-Steckschlüsselklingen

115G



115G-75 8

DIN3126 E6.3, mit Gleitmagnet

Hesse- Art.-Nr.	Modell Herstellernr.	Größe (SW)	L (mm)	UVP in € zzgl. MwSt.
422324	115G-75 8	8	75	18,70
422547	115G-75 10	10	75	18,70
422323	115G-75 13	13	75	21,70
422451	115G-150 8	8	150	21,20
422549	115G-150 10	10	150	21,80

Koken 1/2"

Handschlagschrauber 4112G

Hesse- Art.-Nr.	Modell Herstellernr.	L (mm)	UVP in € zzgl. MwSt.
430800	4112G	163	41,00



AG112A

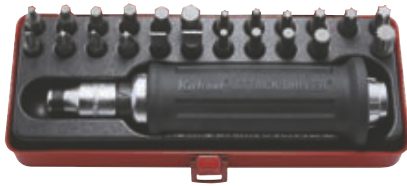

AG112F

Koken 1/2"

Handschlagschrauber Set AG112A/F

Hesse- Art.-Nr.	Modell Herstellernr.	Ausführung	UVP in € zzgl. MwSt.
421010	AG112A Set	AG112A + 4 Bits: ⊕ PH 2+3 / ⊖ Schlitz 9 + 11	65,20
421011	AG112F Set	AG112F + 23 Bits ⊕ PZ + ⊕ PH 2+3 / ⊖ Schlitz 9 + 11 / ● sw 4, 5, 6, 7, 8, 10 / ● T25, T27, T30, T40, T45, T50 / ● XZN M5, M6, M8, M10, M12	144,30

Koken

Türverkleidungs-Lösehebel (Satz) 169/2 (2-teilig)

Hesse- Art.-Nr.	Modell Herstellernr.	Größe (mm)	L (mm)	UVP in € zzgl. MwSt.
422526	169/2 (2-teilig)	6	215	30,90
		10	230	



Koken

Türverkleidungs-Lösehebel 169

Hesse- Art.-Nr.	Modell Herstellernr.	Größe (mm)	L (mm)	UVP in € zzgl. MwSt.
422527	169	10	230	16,40

Koken

Umsteckschraubendreher mit Wechselklinge 168 CS

Hesse- Art.-Nr.	Modell Herstellernr.	L (mm)	UVP in € zzgl. MwSt.
423482	168 CS	86	10,70



Koken by Hesse KG

Koken

Sortiment

Torx Bits-Satz 7/16"

Hesse-Nr.: 499786

UVP:
158,00 €*
zzgl. MwSt.

Torx Bits-Satz 20-teilig mit 7/16" Antrieb zur Aufnahme in Wechseladapter 3/8" und 1/2" für den Einsatz in Schlagschraubern bzw. Industrie-Drehautomaten. Die Bits entsprechen DIN 3126 E 11,2 / ISO 1173 E 11,2.

Alle Werkzeuge können auch einzeln bestellt werden.

Modell Herstellernr.	Hesse- Art.-Nr.	Bezeichnung	SW	Nm	UVP in € zzgl. MwSt.
Torx Bits-Satz 20-teilig	422701	Bit 183T-35	T25	14	6,80
	422657	Bit 183T-35	T30	26	6,80
	422624	Bit 183T-35	T40	46	6,80
	422704	Bit 183T-35	T45	72	6,80
	422625	Bit 183T-35	T50	112	7,00
	422651	Bit 183T-35	T55	180	7,00
	422653	Bit 183T-35	T60	400	11,80
	422659	Bit 183T-35	T30	26	7,50
	422640	Bit 183T-75	T40	46	7,50
	422705	Bit 183T-75	T45	72	7,50
	422650	Bit 183T-75	T50	112	7,50
	434160	Verbindungsstück 12233A-P	1/4" - 3/8"	110	11,70
	441710	Klingenhalter 14134	1/2" - 7/16"	1620	14,60
434444	Klingenhalter 13134	3/8" - 7/16"	404	13,20	
308245	Stiftschlüssel SW 4	4	-	3,25	



183T-35



183T-75

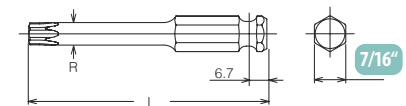

12233A-P

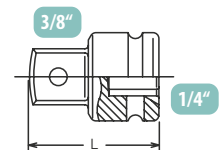

13134



14134

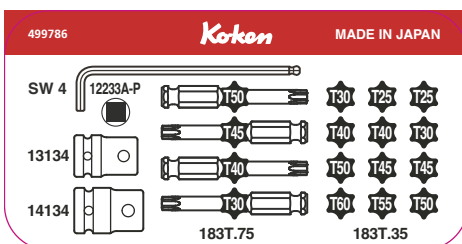
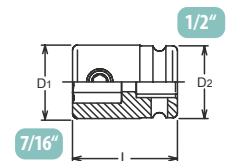
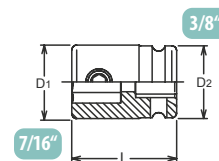

Innensechskant Bits-Satz 7/16"

Hesse-Nr.: 499785

UVP:
162,10 €*
zzgl. MwSt.

Innensechskant Bits-Satz 20-teilig mit 7/16" Antrieb zur Aufnahme in Wechseladapter 3/8" und 1/2" für den Einsatz in Schlagschraubern bzw. Industrie-Drehautomaten. Die Bits entsprechen DIN 3126 E 11,2 / ISO 1173 E 11,2.

Alle Werkzeuge können auch einzeln bestellt werden.

Modell Herstellernr.	Hesse- Art.-Nr.	Bezeichnung	SW	Nm	UVP in € zzgl. MwSt.
Innensechskant Bits-Satz 20-teilig	422674	Bit 183H-35	3	8	5,60
	422702	Bit 183H-35	4	20	5,60
	422649	Bit 183H-35	5	36	5,60
	422654	Bit 183H-35	6	72	5,60
	422637	Bit 183H-35	8	172	5,80
	422655	Bit 183H-35	10	328	5,80
	422636	Bit 183H-35	12	400	9,30
	422712	Bit 183H-35	14	400	9,60
	422656	Bit 183H-35	16	400	9,60
	422648	Bit 183H-75	5	36	7,10
	437492	Bit 183H-75	6	72	7,10
	422628	Bit 183H-75	8	172	7,10
	422629	Bit 183H-75	10	328	7,20
	434160	Verbindungsstück 12233A-P	1/4" - 3/8"	110	11,70
	441710	Klingenhalter 14134	1/2" - 7/16"	1620	14,60
	434444	Klingenhalter 13134	3/8" - 7/16"	404	13,20
	308245	Stiftschlüssel SW 4	4	-	3,25



183H-35



183H-75

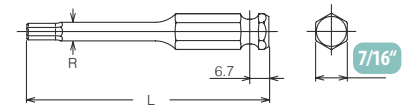

12233A-P

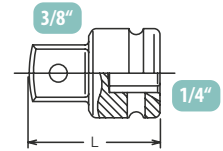

13134



14134

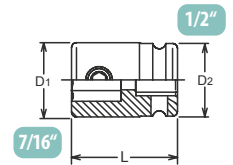
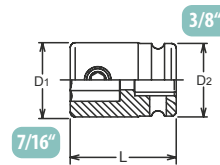

499785 **Koken** MADE IN JAPAN

SW 4 12233A-P

13134

14134

183H.75 183H.35

Sortiment

6-Kant Box

Koken

UVP:
282,20 €*
zzgl. MwSt.

Hesse-Nr.: 499803

15-teiliger Satz Impact Steckschlüssel – Sechskant-Aufnahme E 6,3 und Steckschlüssel mit 1/4" Innenvierkant. Als Impact Steckschlüssel können die Werkzeuge in Druckluft- und Akkuschraubern eingesetzt werden. Mit einem Magneten bestückt, halten die Werkzeuge die Schrauben sicher fest. Dies ist bei Arbeiten über Kopf und bei der Verarbeitung selbstschneidender Schrauben hilfreich. Die Einsätze mit Kardangelenken erlauben eine Verschraubung in schwer zugänglichen Bereichen.

Alle Werkzeuge können auch einzeln bestellt werden.



Modell Herstellernr.	Hesse- Art.-Nr.	Bezeichnung	SW	UVP in € zzgl. MwSt.
6-Kant Box 15-teilig	434063	110-50B 1/4"	1/4"	7,70
	422444	115-50 7 mm	7	3,70
	422445	115-50 8 mm	8	3,70
	422446	115-50 10 mm	10	4,10
	422321	115-50 3/8" mm	3/8"	5,30
	422448	115-50 13 mm	13	6,60
	422514	113UN-150 8 mm	8	46,20
	422428	113UN-150 10 mm	10	46,20
	422427	113UN-150 13 mm	13	46,20
	422590	12400MG 5.5 mm	5,5	9,20
	422581	12400MG 7 mm	7	9,20
	422583	12400MG 8 mm	8	9,50
	422580	12400MG 10 mm	10	9,90
	434230	12400AG 3/8"	3/8"	10,60
	422601	12400MG 13 mm	13	9,90

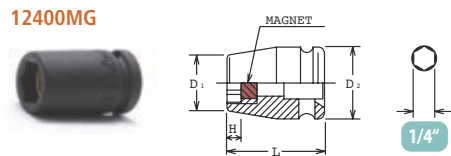
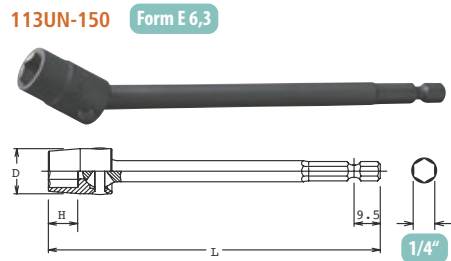
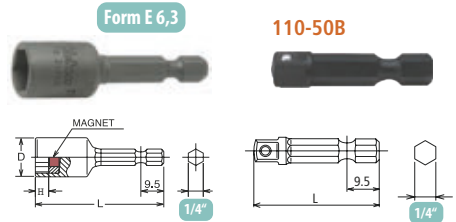

499803 **Koken** MADE IN JAPAN

113-UN

115-50 - 110-50B

8

13

7

10

5,5

3/8



Sortiment

Innensechskant/ Torx 5/16"

Hesse-Nr.: 499806

UVP:
173,30 €*
zzgl. MwSt.

Satz mit Impact Bits und Adaptern. Durch den Antrieb in 5/16" kann gegenüber den kleinen 1/4" Bits deutlich mehr Drehmoment übertragen werden. Alle Bits in 5/16". Innensechskantbits von 3,0 - 14 mm. Torxbits von T10 - T50, mit und ohne Innenbohrung zur Verschraubung von Sicherheitsschrauben. Kreuzschlitzbits Phillips in Gr. 1 - 4 Die Adapter haben jeweils den Antrieb als Innenvierkant in 1/4", 3/8" und 1/2". Bits entsprechend DIN 3126 C8 / ISO 1173 C8.

Alle Werkzeuge können auch einzeln bestellt werden.

Modell Herstellernr.	Hesse- Art.-Nr.	Bezeichnung	SW	UVP in € zzgl. MwSt.
Innensechskant Bits-Satz 34-teilig	425103	100H-32 3 mm	3	3,00
	425105	100H-32 4 mm	4	3,00
	425109	100H-32 5 mm	5	3,00
	425111	100H-32 6 mm	6	3,00
	425118	100H-32 8 mm	8	3,00
	425121	100H-32 10 mm	10	4,30
	425124	100H-32 12 mm	12	4,30
	425127	100H-32 14 mm	14	5,20
	441655	12140	1/4"	11,10
	441675	13140	3/8"	11,90
	441705	14140	1/2"	13,20
	425235	100T-32 T10	8	5,00
	425233	100T-32 T15	8	5,00
	425236	100T-32 T20	8	5,00
	425239	100T-32 T25	8	5,00
	425242	100T-32 T27	8	5,00
	425245	100T-32 T30	8	5,00
	425248	100T-32 T40	8	5,00
	425246	100T-32 T45	8	5,00
	425250	100T-32 T50	8 <td 5,50	
	425237	100T-32 TH10 Loch	8	5,80
	425238	100T-32 TH15 Loch	8	5,80
	425244	100T-32 TH20 Loch	8	5,80
	425240	100T-32 TH25 Loch	8	5,80
	425241	100T-32 TH27 Loch	8	5,80
	425243	100T-32 TH30 Loch	8	5,80
	425273	100T-32 TH40 Loch	8	5,80
	425234	100T-32 TH45 Loch	8	5,80
	425261	100T-32 TH50 Loch	8	6,30
	425274	100T-32 TH55 Loch	8	7,40
	425140	100P-32 No.1	8	2,10
	425143	100P-32 No.2	8	2,10
	425146	100P-32 No.3	8	2,10
	425149	100P-32 No.4	8	2,50



12140



13140



14140



100H-32

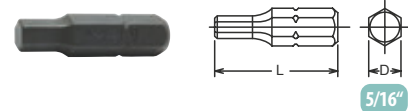

100T-32 / 100T-32 TH

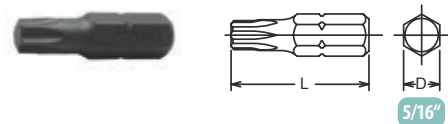

100P-32

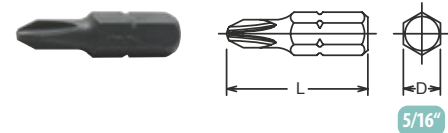

499806 **Koken** MADE IN JAPAN

	3	8	T10	T25	T40	T10H	T25H	T40H
14140	4	10	T15	T27	T45	T15H	T27H	T45H
	5	12	T20	T30	T50	T20H	T30H	T50H
13140	6	14	100T	100TH				T55H
	12140	100H						

Hesse-Nr.: 499807

UVP:
205,30 €*
zzgl. MwSt.

11-teiliger Satz Impact-Werkzeugschäfte in Form E 6,3 zur Aufnahme von Steckschlüsseln in 1/4" – 3/8" und 1/2". Impact Übergangsstücke für Kraftschrauber mit Vierkant. Die sieben Übergangsstücke können mit Bits oder mit Steckschlüsseln bestückt werden.

Alle Werkzeuge können auch einzeln bestellt werden.

Modell Herstellernr.	Hesse- Art.-Nr.	Bezeichnung	Antrieb	UVP in € zzgl. MwSt.
Übergangsstücke 11-teilig	422096	12137E	1/4"	15,30
	441664	13137E	3/8"	15,30
	441694	14137E	1/2"	18,70
	434063	110-50B	1/4"	7,70
	434072	112-50B	3/8"	8,60
	434071	135E-60B	1/2"	11,80
	434160	12233A-P	1/4"	11,70
	434650	13322A-P	3/8"	14,00
	434698	13344A-P	3/8"	14,00
	435900	14433A-P	1/2"	14,80
	499808	110AL-62	1/4"	40,70



12137E

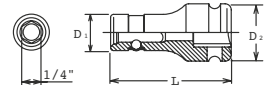

13137E



14137E

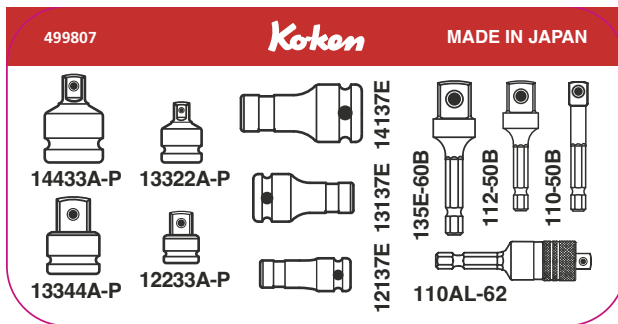

110-50B

Form E 6,3

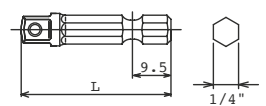

112-50B

Form E 6,3

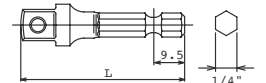

135E-60B

Form E 6,3

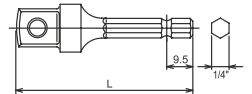

NEU 110AL-62

Form E 6,3

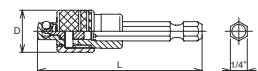

12233A-P

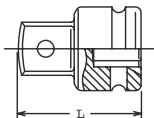

13322A-P

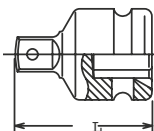

13344A-P

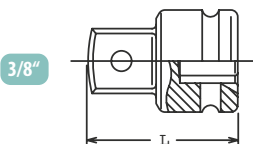

14433A-P

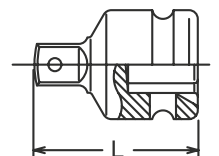

EIGHT® Made in Japan

Stiftschlüssel Set Innen-
sechskant

WTLS-9N



9-teiliges Doppeldecker Set mit Kegelkopf-Sechskantschlüssel.

Hesse- Art.-Nr.	Modell Herstellernr.	Größe (mm)	Material	UVP in € zzgl. MwSt.
443840	Stiftschlüssel Set 9-teilig WTLS-9N	1.5; 2; 2.5; 3; 4; 5; 6; 8; 10	SNCM+V (Oberfläche: EL/Armour)	30,70



"TAPER HEAD"

ohne Federring

Konisch zulaufend

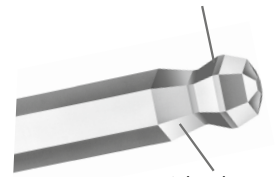

Sehr robustes
Halsstück

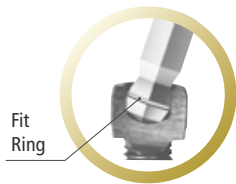

Fit
Ring

"TAPER HEAD" BOLT CATCH mit Federring

Feder-Haltering
ab 2,5 - 10 mm



EIGHT®

Stiftschlüssel Set Innensechskant
mit Feder

WTTBCT-S9N

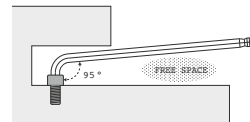

Hesse- Art.-Nr.	Modell Herstellernr.	Größe (mm)	Material	UVP in € zzgl. MwSt.
443843	Stiftschlüssel Set 9-teilig WTTBCT-S9N	1.5; 2; 2.5; 3; 4; 5; 6; 8; 10	SNCM+V (Oberfläche: EL/Armour)	43,90

EIGHT®

Stiftschlüssel Set
Torx® + Kugelkopf

TXBH-S9



9-teiliges Set Torx®. Schlüssel und Kugelkopf.

Hesse- Art.-Nr.	Modell Herstellernr.	Größe (mm)	Material	UVP in € zzgl. MwSt.
443844	Stiftschlüssel Set 9-teilig TXBH-S9	T8; T9; T10; T15; T20; T25; T27; T30; T40	SNCM+V (Oberfläche: EL/Armour)	44,00

Torx® Schlüssel einzeln

443857	TXBH-8	T8	EL/Armour)	5,00
443858	TXBH-9	T9	EL/Armour)	5,00
443859	TXBH-10	T10	EL/Armour)	5,00
443860	TXBH-15	T15	EL/Armour)	5,40
443861	TXBH-20	T20	EL/Armour)	5,90
443862	TXBH-25	T25	EL/Armour)	6,10
443863	TXBH-27	T27	EL/Armour)	6,60
443864	TXBH-30	T30	EL/Armour)	6,80
443865	TXBH-40	T40	EL/Armour)	7,70



XTRA SLIM ROLLGABELSCHLÜSSEL



Made in Spain



Rollgabelschlüssel 92LWD

Hesse- Art.-Nr.	Modell Herstellernr.	Maulöffnung (mm)	Länge (mm)	Gewicht (g)	UVP in € zzgl. MwSt.
600088	92LWD24-6" 571822006005105	24	161	115	28,60
600089	92LWD30-8" 571822008005105	30	207	214	33,70
600090	92LWD36-10" 571822001005105	36	259	345	40,90
600091	92LWD46-12" 571822002005105	46	311	604	54,00



SWO 92XS
Vernickelt &
verchromt



SWO 99XS
brüniert



92XS 4"
vernickelt &
poliert



XTRA SLIM
und kompakt

SWO
Super Große Maulöffnung



Rollgabelschlüssel SWO 92XS/99XS

Der verstellbare Rollgabelschlüssel hat eine bessere Zugänglichkeit dank der Xtra Slim (Xtra dünne Backen) Backenform und mehr Leistung bei kompakter Bauform.

Hesse- Art.-Nr.	Modell Herstellernr.	Maulöffnung (mm) (Zoll)	Länge (mm)	Gewicht (g)	UVP in € zzgl. MwSt.
600098	SWO 92XS/CBE 6" 570909006005105	34 1 5/16"	176	205	33,50
600099	SWO 92XS/CBE 8" 571033108005105	39 1 1/2"	216	330	38,00
600102	SWO 99XS/CBE 6" 570909008005105	34 1 5/16"	176	205	30,20
600103	SWO 99XS/CBE 8" 570909008005105	39 1 1/2"	216	330	33,20
600151	92XS 4" 571201004005106	13	11	40	21,50

Hesse-Art.-Nr.	Modell Herstellernr.	Maulöffnung (mm)	Länge (mm)	Gewicht (g)	UVP in € zzgl. MwSt.
600152	77-24" 570000024009003	62	612	3560	213,30
600153	92W-4" 570100004005106	13	115	52	17,90
600154	92W-6" 570500006005106	24	161	130	19,20
600155	92W-8" 570500008005106	30	207	265	23,80
600156	92W-10" 570500010005106	34	259	430	28,60
600157	92W-12" 570500012005103	39	311	710	38,30
600158	92W-15" 570100015008103	43	386	1290	65,60
600159	92W-18" 570100018008103	53	462	2040	101,30
600160	99WR-8" 571130108005306	34	207	280	26,80
600161	99WR-10" 571130110005306	40	259	450	34,70



Drehbare Backe mit Verzahnung, zum festhalten von Rohren

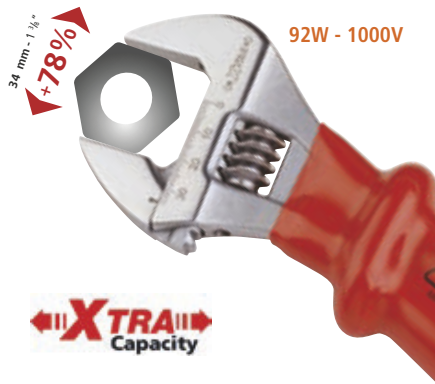

Hesse-Art.-Nr.	Modell Herstellernr.	Länge (mm)	Maulöffnung (mm) (Zoll)	Gewicht (g)	UVP in € zzgl. MwSt.
600092	92W-1000V - 6" 570512006005105	161	24 15/16"	185	40,20
600093	92W-1000V - 8" 570512008005105	207	30 1 3/16"	360	44,70
600094	92W-1000V - 10" 570512010005105	259	34 1 3/8"	570	49,20
600095	92W-1000V - 12" 570512012005405	311	39 1 1/2"	905	66,00

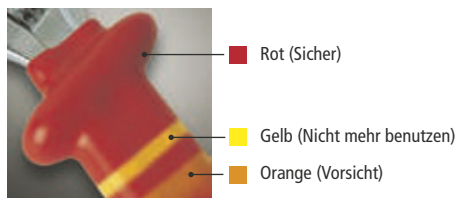

Hesse-Art.-Nr.	Modell Herstellernr.	Länge (mm)	Maulöffnung (mm) (Zoll)	Gewicht (g)	UVP in € zzgl. MwSt.
600100	SWO 92-1000V - 6" 570313006005105	176	34 1 3/8"	250	58,40
600101	SWO 92-1000V - 8" 570313008005105	216	39 1 1/2"	370	63,90



Teleskop-Suchspiegel
versch. Größen

Inspektionsspiegel mit Teleskopstange. Der Glasspiegel ist auf einem drehbaren Gelenk aufgeschraubt.

Hesse-Art.-Nr.	Modell Herstellernr.	Länge (mm)	Gewicht (g)	UVP in € zzgl. MwSt.
460897 <small>GÄNGIG</small>	Runder Spiegel ø 30 475-02	240 mm (eingeklappt) 680 mm (ausgeklappt)	195	13,60
461031 <small>GÄNGIG</small>	Runder Spiegel ø 50 475-05	240 mm (eingeklappt) 680 mm (ausgeklappt)	210	16,30
461051	Runder Spiegel ø 70 461051	240 mm (eingeklappt) 700 mm (ausgeklappt)	157	18,90
461034 <small>NEU</small>	Eckiger Spiegel 43 x 65 475-07	240 mm (eingeklappt) 680 mm (ausgeklappt)	115	17,20
461044	Eckiger Spiegel 100 x 150 475-XL	445 mm (eingeklappt) 1180 mm (ausgeklappt)	115	45,90

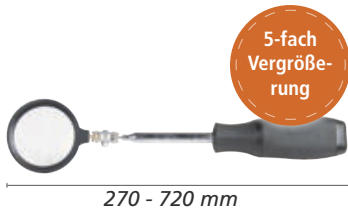

Inspektionslupe
ø 50 mm

Teleskopgriff mit großen, dreieckförmigen Griffen mit Soft-Touch und 5-fach-Vergrößerungslupe. Mit Anti-Twist-Teleskop.

Hesse-Art.-Nr.	Modell Herstellernr.	Länge (mm)	Gewicht (g)	UVP in € zzgl. MwSt.
461053 <small>NEU</small>	Lupe ø 50 461053	270 mm (eingeklappt) 720 mm (ausgeklappt)	132	23,90



Flexibler Magnetheber
versch. Größen

Mit flexibler Welle, Griff aus Polypropylen und Neodym-Magnet mit verschiedenen Haltekräften.

Hesse-Art.-Nr.	Modell Herstellernr.	Magnet ø / Krallenöffnung	Länge d. flexiblen Welle (mm)	Gewicht (g)	UVP in € zzgl. MwSt.
460927	270 g 400-00	3 mm	335	32	7,70
460928 <small>GÄNGIG</small>	500 g 400-01	6 mm	350	120	14,30
460929 <small>GÄNGIG</small>	1.000 g 400-02	12 mm	350	173	18,50
460930	1.800 g 400-03	15 mm	350	183	18,40
460933	3.000 g 400-04	19 mm	400	197	46,00

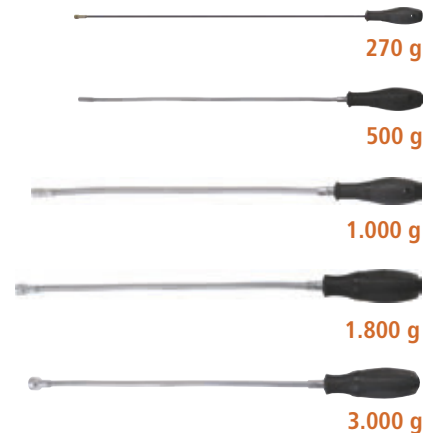

Flexibler Krallengreifer					
Hesse-Art.-Nr.	Modell Herstellernr.	Magnet ø / Krallenöffnung	Länge d. flexiblen Welle (mm)	Gewicht (g)	UVP in € zzgl. MwSt.
460896	250 mm 460-01	15 mm	82	80	18,80
460982	500 mm 460-02	15 mm	325	228	19,20
460983	750 mm 460-03	15 mm	635	310	22,90

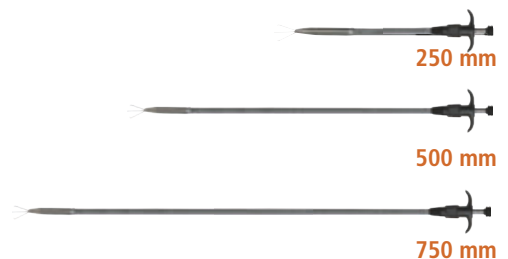



Teleskop Magnetheber
500 g

Teleskop Magnetheber mit Griff,
ausziehbarem, Clip und Anreißnadel



Hesse- Art.-Nr.	Modell Herstellernr.	Magnet ø (mm)	Länge (mm)	Gewicht (g)	UVP in € zzgl. MwSt.
460934	500 g 402-02 KFZ	6	150 mm (eingeklappt) 660 mm (ausgeklappt)	21	4,80
460984	500 g 402-01 IND	6	150 mm (eingeklappt) 660 mm (ausgeklappt)	22	4,80



490068



490069



Uhrmacher Satz
Set

Hesse- Art.-Nr.	Modell Herstellernr.	Ausführung	Gewicht (g)	UVP in € zzgl. MwSt.
490068	1428-6	6-teiliger Inhalt	145	5,70
490069	1428-16	16-teiliger Inhalt	364	11,50



Sortiment
Inspektionsset

Hesse- Art.-Nr.	Modell Herstellernr.	Bestückung 3-teilig	UVP in € zzgl. MwSt.
461010	Inspektions- set	Teleskop Magnetheber mit Ø 40 mm Inspektionsspiegel (461001) Suprabeam Taschenlampe Q1 (488778) Lichtumlenker (zu Suprabeam Q1)	61,90



Hesse Sortiment
Industrie Service Set Premium

Hesse- Art.-Nr.	Modell Herstellernr.	Bestückung 6-teilig	UVP in € zzgl. MwSt.
460964 <small>ÖANGIG</small>	Industrie Service Set Premium in Tasche	Magnetheber 500 g (460928) Krallengreifer 500 mm (460982) Teleskopmagnetheber 500 g (460984) Teleskop-Suchspiegel Ø 50 mm (461031) Teleskopsuchspiegel 43 x 65 mm (461034) / Pen-Light LED (488986)	94,10





LED Stiftlampe
HS 1.120



Hesse-Art.-Nr.	Modell Herstellernr.				UVP in € zzgl. MwSt.
488965	HS 1.120	150 lm	30 m	3x AAA	9,00

eANGIG



LED Stiftlampe
HS 3.120



Hesse-Art.-Nr.	Modell Herstellernr.				UVP in € zzgl. MwSt.
488986	HS 3.120	124 lm	22 m	2x AAA	21,80



LED Stiftlampe
**HS 1.120/
HS 10.120 USB-C**



488972

Hesse-Art.-Nr.	Modell Herstellernr.				UVP in € zzgl. MwSt.
489084	HS 1.120 USB-C	160 lm	30 m	1x Li-Ion, 800 mAh	13,60
488972	HS 10.120 USB-C	160 lm	30 m	1x Li-Ion, 800 mAh	13,60



LED Stiftlampe
HS 3.120R (USB)



Hesse-Art.-Nr.	Modell Herstellernr.				UVP in € zzgl. MwSt.
488980	HS 3.120	114 lm	34 m	1x Li-Ion 320 mAh	34,60



LED Inspektionsleuchte
HUV 2.180



488996

488990

Hesse-Art.-Nr.	Modell Herstellernr.				UVP in € zzgl. MwSt.
488996	HUV 2.180	150 lm	30 m	3x AAA	36,10
488990	HUV 1.180	80 lm	34 m	1x AA	30,00



LED Taschenlampe
HM 7.180



Hesse-Art.-Nr.	Modell Herstellernr.				UVP in € zzgl. MwSt.
489893	HM 7.180	250 lm	160 m	3x AAA	9,00



LED Taschenlampe
HM 7.110



Hesse-Art.-Nr.	Modell Herstellernr.				UVP in € zzgl. MwSt.
480083	HM 7.110	250 lm	160 m	3x AAA	9,00



LED Kopflampe
HT 2.120



Hesse-Art.-Nr.	Modell Herstellernr.				UVP in € zzgl. MwSt.
488977	HT 2.120	200 lm	60 m	3x AAA	11,50



LED Kopflampe
HT 2.120 USB-C

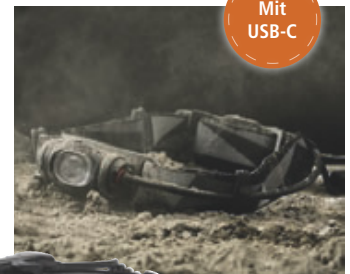

Mit USB-C

4 Leuchtmodi

Hesse-Art.-Nr.	Modell Herstellernr.				UVP in € zzgl. MwSt.
488987	HT 2.120 USB	521 lm	85 m	1x Li-Ion, 2600 mAh	56,20



Arbeitslampe

Prolyx Work 9W



LED IP63

Hesse-Art.-Nr.	Modell Herstellernr.			Gewicht (g)	UVP in € zzgl. MwSt.
489931	Prolyx Work 9W MOD.P-ML	1000 lm	EURO Stecker	1900	213,70



LED Inspektionsleuchte

Medusa S/M

LED IP54 UV



Hesse-Art.-Nr.	Modell Herstellernr.			Gewicht (g)	UVP in € zzgl. MwSt.
489875	Medusa S 600.07	25 lm	150 Std.	256	60,90
489879	Medusa M 600.05	25 lm	150 Std.	251	70,90



Batterie

AAA / AA



Hesse-Art.-Nr.	Modell Herstellernr.	Batterien	VE	UVP in € zzgl. MwSt.
480229	E300171802	AAA	10	15,50
489877	139210	AAA	12x 10	77,40
489876	139110	AA	12x 10	90,90



Batterie

CR 2032



Hesse-Art.-Nr.	Modell Herstellernr.	Batterien	VE	UVP in € zzgl. MwSt.
489759	CR 2032	CR 2032	1	2,20



Batterie

AAAA - 9 V-Block

Hesse-Art.-Nr.	Modell Herstellernr.	Batterien	VE	UVP in € zzgl. MwSt.
489805	MN2500-AAAA	AAAA	1	7,90
490052	4903424	AAA	4	4,00
490053	4906424	AA	4	4,00
490054	4906424	C	2	4,20
490055	4906424	D	2	6,00
489752	4906424	9 V-Block	1	3,90



AAAA



AAA



9 V-Block



AA



C



D



Spannungsprüfer, einpolig
120 - 250 V

480095

480127

Hesse- Art.-Nr.	Modell Herstellernr.	Spannung (V)	Abtrieb	VE	UVP in € zzgl. MwSt.
480095	45200	120 - 250	3 x 60 x 140	1	1,20
480168	945200	120 - 250	3 x 60 x 140	12	15,00
480127	45700	125 - 250	3,5 x 100 x 190	1	1,50



Spannungsprüfer, einpolig
125 - 250 V

Hesse- Art.-Nr.	Modell Herstellernr.	Abtrieb	Länge (mm)	Gewicht (g)	UVP in € zzgl. MwSt.
480120	45300	3 x 60 x 140	150	20	1,80
480109	45800	3,5 x 100 x 190	190	28	2,20



Messleitung

Silikonmessleitung

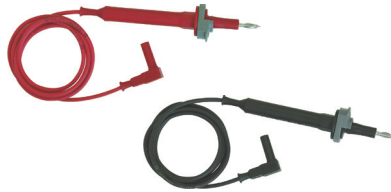

Hesse- Art.-Nr.	Modell Herstellernr.	Farbe	Länge (mm)	Gewicht (g)	UVP in € zzgl. MwSt.
483056	5949-IEC-120-R	●	1380	61	26,90
483057	5949-IEC-120-N	●	1380	61	26,90



Multimeter, digital

HDT



480150



480175



Ersatzsicherung
200 mA



Hesse- Art.-Nr.	Modell Herstellernr.	Spannung	Strom	Widerstand	Temperatur (C°)	Maße (mm)	Gewicht (g)	UVP in € zzgl. MwSt.
480150	HDT 60	2 - 600 V	200	2 k - 2 MOhm	- 40 bis + 400	145 x 72 x 40	245	43,10
480175	HDT 65	600 mV - 1000 V	600 µA- 10 A	60 Ohm - 200 MOhm	- 200 bis + 1350	150 x 80 x 45	350	90,70

480245	Ersatzsicherung zu Multimeter HDT 60 200 mA							6,80
480253	Ersatzsicherung zu Multimeter HDT 60 10 A							2,50
480275	Ersatzsicherung zu Multimeter HDT 65 0,63 A							4,60
480277	Ersatzsicherung zu Multimeter HDT 65 10 A							6,60



Spannungsprüfer
Autolichtprüfer

Hesse- Art.-Nr.	Modell Herstellernr.	Länge (mm)	Gewicht (g)	UVP in € zzgl. MwSt.
480184	480184	880	64	6,40

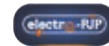

Prüfleitungsset

Industrie KIT-HH-1



Hesse- Art.-Nr.	Modell Herstellernr.	Länge (mm)	Gewicht (g)	UVP in € zzgl. MwSt.
483055	1039	275	63	89,10



Messleitung

rot/schwarz



Hesse- Art.-Nr.	Modell Herstellernr.	Länge (mm)	Gewicht (g)	UVP in € zzgl. MwSt.
480170	1039	1200	45	15,00

ASIMETO

Digitaler ABS-Messschieber

Premium Line

DIN 862 | Auflösung 0,01 mm

Hesse- Art.-Nr.	Modell Herstellernr.	Arbeitsbereich (mm)	Genauigkeit (mm)	UVP in € zzgl. MwSt.
485005	307-56-2	0 - 150	± 0,02	60,70
485010	307-58-2	0 - 200	± 0,03	84,20



ASIMETO

Messschieber mit Feststellschraube mit rundem Tiefenmaß

Nonius

DIN 862 | Ablesung 0,05 mm / 1/128"

Hesse- Art.-Nr.	Modell Herstellernr.	Arbeitsbereich (mm)	Genauigkeit (mm)	UVP in € zzgl. MwSt.
GANGIO 485015	341-06-2	0 - 150	0,05	28,10



ASIMETO

Digitales Mikrometer

ABS Bügelmessschraube

DIN 863-1 | Auflösung 0,001 mm | IP 65

Hesse- Art.-Nr.	Modell Herstellernr.	Arbeitsbereich (mm)	Genauigkeit (µm)	UVP in € zzgl. MwSt.
485018	105-01-4	0 - 25	± 2	102,50

ASIMETO

Stahlmaßstab

122/124

Skala beidseitig skaliert

Hesse- Art.-Nr.	Modell Herstellernr.	Länge (mm)	Teilung	UVP in € zzgl. MwSt.
485131	122-001	100	inch / mm	3,00
485130	122-01	150	(Halb-) mm	3,10
485132	122-02	200	(Halb-) mm	3,60
485134	124-04	300	mm	5,10
485136	124-05	500	mm	6,10
485138	124-07	1000	mm	12,20



122-01 - 150 MM



Gliedermaßstab

2m / 3m

Skala beidseitig skaliert

Hesse- Art.-Nr.	Modell Herstellernr.	Länge (mm)	Ausführung	UVP in € zzgl. MwSt.
483900	21236	2000	Aluminium	18,40
483901	23169	3000	gelb/weiß	13,90



483900

483901

173



Abisolierwerkzeug

Kabifix 28



Hesse- Art.-Nr.	Modell Herstellernr.	Arbeitsbereich (mm)	Länge (mm)	UVP in € zzgl. MwSt.
460794	FK-28 20509	6 - 28	90	34,30



Anlegewerkzeug mit Sensor

LSA Plus S



Hesse- Art.-Nr.	Modell Herstellernr.	Leiter ø (mm)	Maße (mm)	UVP in € zzgl. MwSt.
486457	6417 2 05501	0,35 - 0,9 0,7 - 1,6	185 x 35	55,40

ENGINEER

Zangen Versch. Zangen aus Carbon Stahl mit Griffhüllen aus TPR (Thermoplastischer Gummi).

PZ

Hesse- Art.-Nr.	Modell Herstellernr.	Arbeitsbereich (mm)	Länge (mm)	Gewicht (g)	UVP in € zzgl. MwSt.
420127	PZ 57	2,0 - 3,5	125	100	21,20
420124	PZ 58	3,0 - 9,5	160	130	24,20
420129	PZ 60	2,0 - 5,5	200	200	34,20
420131	PZ 78	3,0 - 9,5	225	350	36,20



Kombizange PZ 57



Mit
Öffnungs-
feder



Telefonzange PZ 60



Kraft-Kombizange PZ 60



Flachzange

KMC 607



Hesse- Art.-Nr.	Modell Herstellernr.	Länge Zangen- maul (mm)	Länge (mm)	UVP in € zzgl. MwSt.
498809	KMC 607	34	150	21,50



Seitenschneider

KMC 037H

Hesse- Art.-Nr.	Modell Herstellernr.	Schneidbereich ø (mm)	Länge (mm)	Gewicht (g)	UVP in € zzgl. MwSt.
498808	KMC 037H	Weicher Draht: 0,2 - 1,2 Standard Draht: 0,18 - 0,9	125	53	33,20
498834	MN-A04	Draht: 0,2-1,6	100	60	29,80
498835	MN-A05	Draht: 0,2-2,0	125	70	30,70



KMC 037H



MN-A04



MN-A05



Sicherungsringzangen

S 025 - 027



S 025

Hesse- Art.-Nr.	Modell Herstellernr.	Arbeitsbereich (mm)	Länge (mm)	Gewicht (g)	UVP in € zzgl. MwSt.
498831	S 025	2,0 - 9,0	125	60	45,50
498832	S 026	10,0 - 40,0	143	85	45,50
498833	S 027	20,0 - 52,0	143	85	45,50



Kerbzangen

100A / 500A / 600A



100A

Hesse- Art.-Nr.	Modell Herstellernr.	Arbeitsbereich (mm)	Länge (mm)	UVP in € zzgl. MwSt.
460922	100A/ rot (Griff)	1,5 - 6,0	235	21,40
460925	500A/ gelb (Griff)	0,5 - 6,0	235	25,50
460923	600A/ blau (Griff)	0,5 - 6,0	235	23,90



Schlosserhammer
377



Hesse-Art.-Nr.	Modell Herstellernr.	Ausführung	UVP in € zzgl. MwSt.
489561	377-200	200 g	7,60
489558	377-300	300 g	9,00
489563	377-500	500 g	11,20
489567	377-800	800 g	15,20

BÄNIG

BÄNIG



Fäustel
501



Hesse-Art.-Nr.	Modell Herstellernr.	Ausführung	UVP in € zzgl. MwSt.
489571	501-1000	1000 g	11,90

BÄNIG



Schlagschnurerät
8092-0



Hesse-Art.-Nr.	Modell Herstellernr.	Länge (mm)	Länge Schlagschnur	UVP in € zzgl. MwSt.
470023	8092-0	130	30 m x ø 1 mm	15,90



Ringpinsel
Solid Pro Gr. 04



Hesse-Art.-Nr.	Modell Herstellernr.	Größe	Borstenlänge (mm)	Dicke (mm)	UVP in € zzgl. MwSt.
480549	Solid Pro	04	64	24	1,93



Gipsbecher
ø 12,5 cm



Hesse-Art.-Nr.	Modell Herstellernr.	Maße (mm)	UVP in € zzgl. MwSt.
480536	Gipsbecher	125 x 95	1,43



Spachtel
40 mm



Hesse-Art.-Nr.	Modell Herstellernr.	Spachtelbreite (mm)	UVP in € zzgl. MwSt.
480546	Spachtel	40	2,68



Reißnadel
E-1



Hesse-Art.-Nr.	Modell Herstellernr.	Länge (mm)	Gewicht (g)	UVP in € zzgl. MwSt.
490125	5270-150	155	36	8,90



Baueimer
12 Liter



Hesse-Art.-Nr.	Modell Herstellernr.	Volumen (l)	UVP in € zzgl. MwSt.
488420	Baueimer	12	1,93



Taschenfederwaage
25/50/100 kg



Hesse-Art.-Nr.	Modell Herstellernr.	Zugkraft (kg)	Gewicht (g)	UVP in € zzgl. MwSt.
480515	25 kg	25	171	9,80
480516	50 kg	50	319	14,20
480517	100 kg	100	605	22,80



Tieflochmarker
K-710-H



Hesse-Art.-Nr.	Modell Herstellernr.	Länge (mm)	Gewicht (g)	UVP in € zzgl. MwSt.
490109	K-710-H schwarz	145	17	6,00
490108	K-710-H rot	145	17	6,00
490109	K-710-H blau	145	17	6,00

**TOUGHER
BY DESIGN**

Die Gorillas sind los!

THE SHAPE MAKES THE DIFFERENCE

484110 - 350 mm/14"

484112 - 600 mm/24"

484114 - 900 mm/36"

484116 - 1200 mm/48"

GORILLA BAR SET - 3 PIECE
350mm/14" 600mm/24" AND 900mm/36"
484125 - 350 mm/ 600 mm/ 900 mm



64-644



64-642

**ROUGHNECK
GORILLA**

Paletten-Heber
43" / 18"

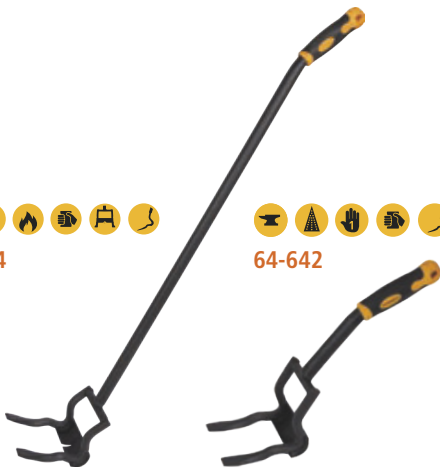

Hesse- Art.-Nr.	Modell Herstellernr.	Länge (mm)	Gewicht (g)	UVP in € zzgl. MwSt.
484143	Dach-Abbruch und Hebelstange 64-642	950 / 18"	1.780	44,20
484140	Paletten-Heber 43" 64-644	1111,5 / 43"	2.980	43,80



**ROUGHNECK
GORILLA**

Sortiment
Brecheisen Set



Hesse- Art.-Nr.	Modell Herstellernr.	Bestückung	UVP in € zzgl. MwSt.
484138	Brecheisen Set 5-teilig 64-961	Brechstange 330 mm (64-493) Brechstange 356 mm (64-405) Brechstange 381 mm (64-415) Nageleisen 178 mm (64-494) Nageleisen 305 mm (64-412)	44,80

**ROUGHNECK
GORILLA**



Sortiment
Brecheisen



Hesse- Art.-Nr.	Modell Herstellernr.	Ausführung (3-teilig)	UVP in € zzgl. MwSt.
484125 GÄNGIG	Sortiment 64-400	Brecheisen 14" (64-405) Brecheisen 24" (64-407) Brecheisen 36" (64-409)	70,40



**ROUGHNECK
GORILLA**

Nageleisen
7" / 15"



Hesse- Art.-Nr.	Modell Herstellernr.	Länge (mm)	Gewicht (g)	UVP in € zzgl. MwSt.
484108 GÄNGIG	Nageleisen 7" 64-492	190/18	168	6,00
484150 GÄNGIG	Nageleisen 7" 64-494	190	168	6,60
484152 GÄNGIG	Nageleisen 15" 64-494	387	660	11,10



**ROUGHNECK
GORILLA**

Brecheisen
64



Hesse- Art.-Nr.	Modell Herstellernr.	Länge (mm)	Gewicht (g)	UVP in € zzgl. MwSt.
484110 GÄNGIG	Brecheisen 64-405	365 / 14"	1.100	10,80
484112 GÄNGIG	Brecheisen 64-407	640 / 24"	3.200	22,70
484114 GÄNGIG	Brecheisen 64-409	914 / 36"	4.750	30,10
484116 GÄNGIG	Brecheisen 64-410	1200 / 48"	6.250	37,70



**ROUGHNECK
GORILLA**

Sortiment
Brecheisen



Hesse- Art.-Nr.	Modell Herstellernr.	Ausführung (2-teilig)	UVP in € zzgl. MwSt.
484120	Sortiment 64-400	Brecheisen 14" (64-405) Brecheisen 24" (64-407)	40,00

ROUGHNECK
GORILLA

Hammer

Club Hammer



Hesse- Art.-Nr.	Modell Herstellernr.	Gewicht (kg)	UVP in € zzgl. MwSt.
484106	Club Hammer 11-130	1,1	23,40
484121	Club Hammer Gorilla 11-030	1,1	37,40

ROUGHNECK
GORILLA

Hammer

Maurerhammer



Hesse- Art.-Nr.	Modell Herstellernr.	Gewicht (kg)	Länge (mm)	UVP in € zzgl. MwSt.
484119	Maurerhammer 11-020	0,567	280	35,10

ROUGHNECK
GORILLA

Hammer

V-serie Zimmermannshammer



Hesse- Art.-Nr.	Modell Herstellernr.	Gewicht (g)	UVP in € zzgl. MwSt.
484115	Zimmermannshammer 11-010	567	37,40

ROUGHNECK
GORILLA

Ziegelmeißel

Block Buster



Hesse- Art.-Nr.	Modell Herstellernr.	Länge (mm)	UVP in € zzgl. MwSt.
484101	Block Buster 31-900	230	35,30

ROUGHNECK
GORILLA

Hebeleisen

11-094



Hesse- Art.-Nr.	Modell Herstellernr.	Länge (mm)	UVP in € zzgl. MwSt.
484105	Block Buster 11-094	250 / 10"	25,70

ROUGHNECK
GORILLA

Micro Schaufel

68-004



Hesse- Art.-Nr.	Modell Herstellernr.	Länge (mm)	UVP in € zzgl. MwSt.
484170	Micro Schaufel 68-004	690 / 27"	23,70

ROUGHNECK
GORILLA

Hammer

Vorschlaghammer



3,0 kg



Hesse- Art.-Nr.	Modell Herstellernr.	Gewicht (kg)	UVP in € zzgl. MwSt.
484165	Vorschlaghammer 65-613	3,0	52,00
484166	Vorschlaghammer 65-614	4,0	60,70
484167	Vorschlaghammer 65-615	5,0	69,30

ROUGHNECK
GORILLA

Stahlbürste Karbonstahl

Block-Drahtbürste



Hesse- Art.-Nr.	Modell Herstellernr.	Länge (mm)	UVP in € zzgl. MwSt.
484133	Block-Drahtbürste 52-050	165	10,50

ROUGHNECK
GORILLA

Sortiment

Meißel Set



Hesse- Art.-Nr.	Modell Herstellernr.	Ausführung	UVP in € zzgl. MwSt.
484103	Meißel Set, 4-teilig 31-934	1x Betonmeißel, 1x Beton Spitzmeißel, 2x Flachmeißel	77,30

ROUGHNECK
GORILLA

Sägebock 2er-Set

Colt 600E Sägebock



Hesse- Art.-Nr.	Modell Herstellernr.	Ausführung	UVP in € zzgl. MwSt.
484131	600E, 2er-Set 35-602	Tragfähigkeit von 589 kg, im Paarbetrieb sogar 1178 kg	237,60

Unsere Empfehlung für Ihr Lagerprogramm:

Weidmüller 



stripax®
480750



PZ 6 Roto
480811



KT 8
480778



PZ 16
480772

HellermannTyton



VT Digi
480073



VT
480079



EVO 7i
486036



ShrinkKit 321 Universal
485807

JOKARI
original



No. 15
460238



No. 28 H Secura
460075



Super 4 Plus
460100



No. 12
460125

SapiSelco



7,5 x 360 mm
491117



7,5 x 540 mm
491064



4,5 x 280 mm
491112



4,5 x 360 mm
491048

SB



105-200RP
491131



472/M03
400172



820 M 03
400184



680 NH-Sicherung
460940

NT Cutter



A-300 GRP, 9 mm
489642



L-500 GRP, 18 mm
489643

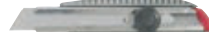

L-500 GP, 18 mm
489644



L-500 RP, 18 mm
489942

LUTZ BLADES
exactly



AB-2 FB SW
470045



AB2-FB SB TiN
480573



EGK6395-SZ, Standard
489625

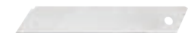

AB2-KB, Standard
480596

Tajima



LC500
470077



LC520
470096



LC500C40
470080



VR103
470101

ROUGHNECK
GORILLA



Gorilla Bar 36" / 914 mm
484114



Gorilla Bar 48" / 1200 mm
484116



MS 450
498839



MS 600
480523

HIT®

Hultafors**Hesse-Meter
270-2-10**

480270

**Schwedenmeter
59-2-10**

480205

**Talmeter
3 m/16 mm**

483120

**Trockenmarker**

483179

**ST
LINE****Atomik WH**

488061

**V-ROCK TURTLE PTS**

488153

**Monolith LT35**

489082

**702 Contractor line**

488311

PLANO**556 TB**

488370

**545TB**

488360

**1975 Z0**

488421

**3315 Z0**

491001

PELI**suprabeam®****2755Z0 HeadsUp Lite**

489513

**Q1**

488778

**Q3r**

489095

**M6xr**

489259

LEATHERMAN®**Wave® Plus**

488647

**Surge®**

488674

**Wingman®**

488944

**Fieldmaster**

488841

Hesse III**Holzschalenmesser**

480605

**Taschenmesser**

480608

**Arbeitsmesser**

480662

**Elektrikermesser**

480609

Hesse III**Kevlar®
Gewebescherer**

480554

**Arbeitsschere 240 mm**

480720

**Combi-Schere
4255/PL**

480671

**Kabelschere 4837**

480672

Hesse III**Inspektionsspiegel
Ø 30 mm**

460897

**Krallengreifer
460-02**

460982

**Inspektionsspiegel
Ø 50 mm**

461031

**Magnetheber
1.000 g**

460929

Hesse III**Pen Light LED
HS 1.120**

488965

**Pen Light LED
HS 1.120 USB-C**

488972

**Kopflampe LED
HT 2.120**

488977

**Taschenlampe
7.110**

480083

Verkaufs- und Lieferbedingungen

1. Anerkennung der Verkaufsbedingungen

Für alle Verkäufe gelten die nachstehenden Bedingungen. Abweichungen müssen schriftlich oder mündlich getroffen werden. Sofern der Kunde nicht innerhalb von 8 Tagen nach der Zustellung unserer Verkaufs-, Lieferungs- und Zahlungsbedingungen Widerspruch eingelegt hat, gelten diese in vollem Umfang.

2. Angebot und Vertragsabschluss

Alle Angaben sind für uns freibleibend. Aufträge gelten erst dann als angenommen, wenn sie von uns schriftlich bestätigt sind. Angebot und Auftragsbestätigung bilden zusammen die darin enthaltenen Verkaufs-, Lieferungs- und Zahlungsbedingungen.

3. Technische Angaben

Alle Angaben ohne Gewähr. Technische Änderungen vorbehalten.

4. Preise

Alle angegebenen Preise verstehen sich in EURO netto zzgl. der gesetzlichen MwSt.

Unsere Preise sind immer freibleibend und können ohne vorherige Ankündigung geändert werden. Wir behalten uns vor, die am Tage der Auslieferung gültigen Preise zu berechnen. Versandkosten sind nicht in unseren Preisen enthalten und werden gesondert berechnet.

5. Lieferzeit und höhere Gewalt

Die Angabe der Lieferzeit erfolgt nach bestem Wissen, aber ohne Gewähr. Ereignisse höherer Gewalt berechtigen uns, die Lieferungen zu verschieben. Unter höherer Gewalt gelten Katastrophen, Feuer, Streiks, Unruhen, Krieg und kriegsähnliche Zustände.

6. Lieferung und Versand

Die Lieferung erfolgt ab Lager Wuppertal. Lieferungen innerhalb der Bundesrepublik Deutschland erfolgen ab einem Netto-Bestellwert von 500,00 EUR frachtfrei bis zur Empfangsstation einschließlich Verpackungskosten. Die frachtfreie Lieferung gilt ausschließlich für Lieferungen innerhalb Deutschlands und nur für Paketsendungen. Bei Exportlieferungen erfolgt die Lieferung frachtfrei bis zur deutschen Grenze bzw. FOB Hamburg/Bremen/Kiel.

Für Lieferungen innerhalb Deutschlands mit einem Netto-Bestellwert unter 500,00 EUR wird eine Versandkostenpauschale in Höhe von 7,00 EUR pro Paket berechnet. Exportlieferungen werden zu den jeweils anfallenden Versandkosten ausgeführt.

Eine Transportversicherung wird nur auf ausdrücklichen Wunsch des Bestellers und auf dessen Kosten abgeschlossen.

Der Versandweg wird von uns nach pflichtgemäßem Ermessen bestimmt

7. Mängelrügen

Beanstandungen werden nur anerkannt, wenn diese innerhalb von 8 Tagen nach dem Empfang der Ware geltend gemacht werden und Materialfehler oder falsch gelieferte Ausführungen nachgewiesen werden und feststeht, dass es sich um von uns gelieferte Ware handelt.

In diesem Fall tauschen wir die fehlerhafte Ware kostenlos aus. Schadenersatzansprüche können nicht geltend gemacht werden.

8. Zahlungsbedingungen

Unsere Rechnungen sind zahlbar innerhalb von 8 Tagen nach Rechnungsdatum und abzüglich von 2 % Skonto oder nach 30 Tagen netto.

Beträge unter 50,00 EUR sind sofort ohne Abzug zahlbar. Bei Zielüberschreitungen werden Verzugszinsen in Höhe von 2% über den jeweiligen Kreditsatz berechnet. Die Annahme von Wechseln oder Schecks behalten wir uns ausdrücklich vor; sie werden grundsätzlich nur zahlungshalber angenommen und gelten erst nach Einlösung als Zahlungsmittel mit befreiender Wirkung. Diskont- und Bankspesen gehen zu Lasten des Bestellers.

9. Eigentumsvorbehalt

Die von uns gelieferten Waren bleiben bis zur vollständigen Bezahlung unser Eigentum. Als Bezahlung gilt der Eingang des Gegenwertes bei uns. Der Besteller ist zur Veräußerung der Vorbehaltsware berechtigt; eine Verpfändung oder Sicherungsübereignung ist ihm jedoch nicht gestattet.

Der Kunde ist gehalten, unsere Rechte beim Weiterverkauf der Vorbehaltsware auf Kredit zu sichern. Darüber hinaus tritt der Besteller schon jetzt seine Forderung aus der Weiterveräußerung der Vorbehaltsware an uns ab. Wir nehmen diese Abtrittserklärung an.

Auf unser Verlangen hat der Kunde die zur Einbeziehung erforderlichen Angaben über die abgetretenen Forderungen zu machen und dem Schuldner die Abtretung mitzuteilen. Wird die Vorbehaltsware zusammen mit anderen Waren weiterveräußert, so gilt die in Abs. 1 vereinbarte Vorausabtretung nun in Höhe des Wertes der Vorbehaltsware, die zusammen mit anderen Waren Gegenstand des Liefergeschäftes ist.

10. Erfüllungsort und Gerichtsstand

Erfüllungsort und Gerichtsstand für Lieferungen und Zahlungen ist Wuppertal.

11. Gültigkeit unserer Bedingung oder auch „Salvatorische Klausel“

Die hier aufgeführten Bedingungen bleiben auch dann in Kraft, wenn eine oder mehrere von ihnen unwirksam werden.

Bankverbindungen:

Commerzbank AG Wuppertal · BLZ 330 800 30 · Kto-Nr. 50 50 595

Swift: DRESDEFF332 · IBAN: DE49 3308 0030 0505 0595 00

Nationalbank Wuppertal · BLZ 360 200 30 · Kto-Nr. 676 99 69

Swift: NBAGDE3E · IBAN: DE05 3602 0030 0006 7699 69

Postbank Köln · BLZ 370 100 50 · Konto-Nr. 224 638-501

Swift: PBNKDEFF · IBAN: DE56 3701 0050 0224 6385 01

USt-Id.-Nr. DE 121106970 · HRA 14838 · Amtsgericht Wuppertal

Heinz Hesse KG

Yale-Allee 17

42329 Wuppertal

Telefon: +49 (0)202-73 42 82

Telefax: +49 (0)202-73 40 27

Internet: www.heinz-hesse-kg.de

Email: info@heinz-hesse-kg.com

